

Technical Specification

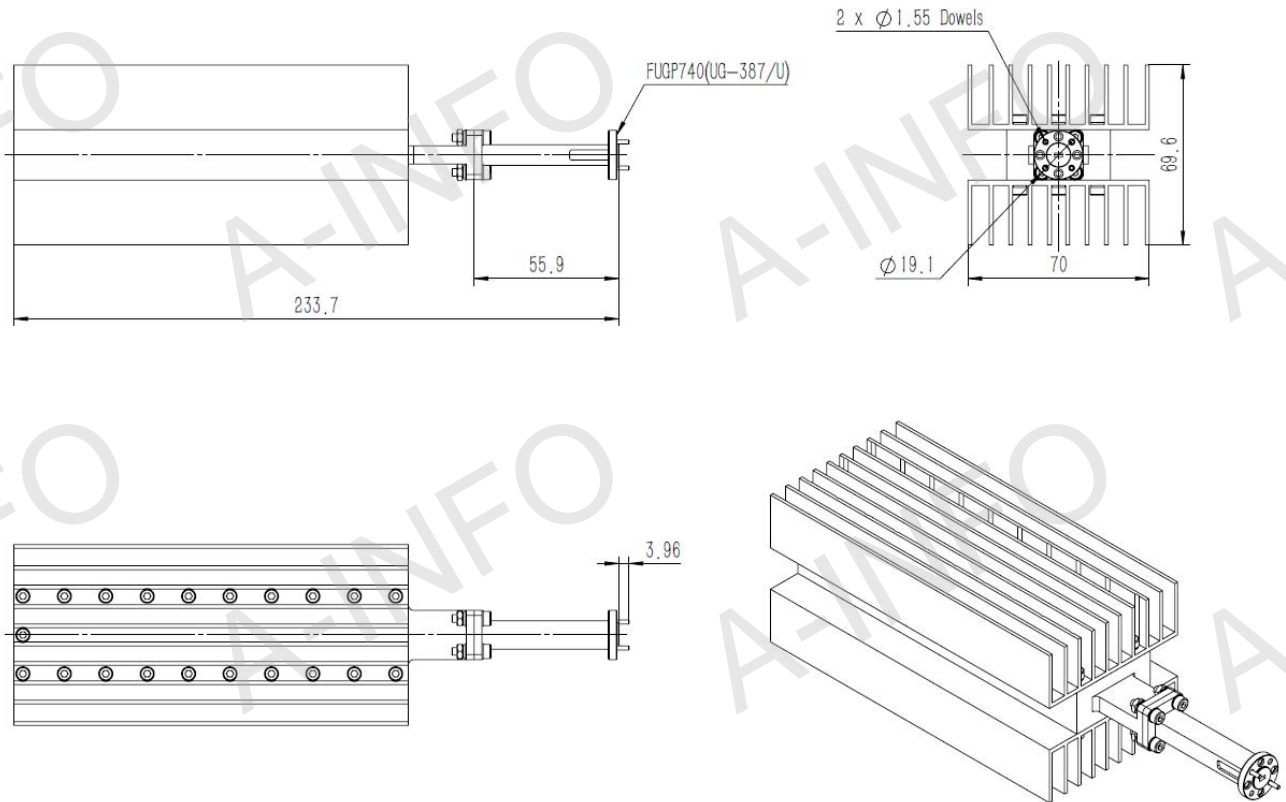

EIA WR	WR12
Frequency Range(GHz)	60.0-90.0
VSWR	1.2:1 Max.
Average Power(W)	200 CW
Peak Power(KW)	40
Flange	FUGP740(UG-387/U)
Material	Al
Size(mm) LxBxC	233.7 x 70 x 69.6
Net Weight(Kg)	0.8 Around

Outline Drawing (Size: mm)



Flange Drawing (Size: mm)

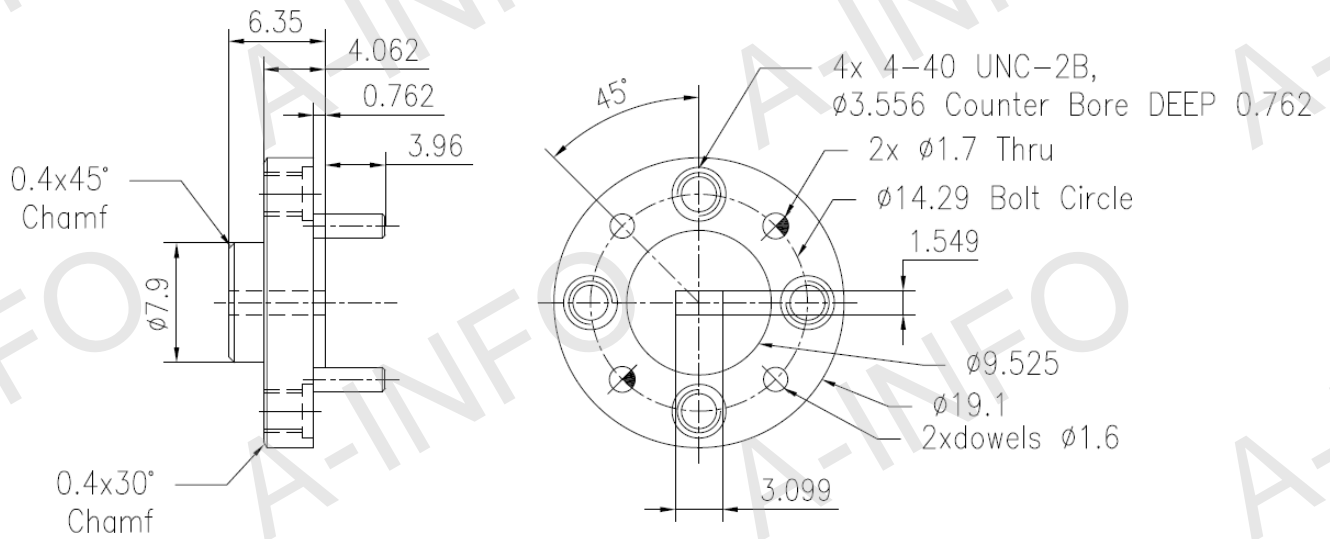

FUGP740
(equivalent to UG-387/U)

Test Results

VSWR (@60-70GHz)



VSWR (@70-90GHz)

