



Features

- Low switching losses
- Low gate charge
- Fast High frequency operation
- Fast reverse recovery body diode
- Tight variation of $R_{DS(on)}$ with temperature

V_{DS}	1200V
$I_D (T_c = 25^\circ C)$	42.9A
$R_{DS(on)}$	80mΩ

Benefits

- Increase efficiency
- Increase power density
- Reduce cooling requirements
- Reduce system cost

Applications

- Solar inverters
- EV charging
- Switch mode power supplies
- Motor drives
- Energy Storage
- UPS



TO-247-4L

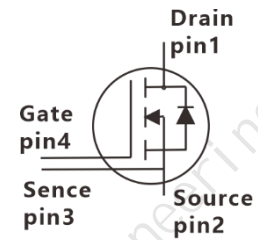

Inner Circuit

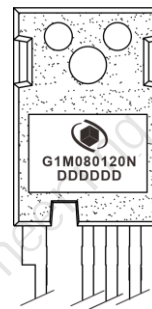

G = GPT
1 = Gen1
M = SiC MOSFET
080 = $R_{DS(on)}$ 80mΩ
120 = Voltage Rating 1200V
N = TO-247-4L
DDDDDD = Traceable code





Maximum Ratings (at $T_J = 25\text{ }^\circ\text{C}$, unless otherwise specified)

Parameter	Symbol	Value	Unit
Drain-Source Voltage	V_{DSS}	1200	V
Gate-Source Voltage Max Transient Voltage, <1% duty cycle Recommend Drive Voltage	V_{GS} $V_{GS(op)}$	-8/+22 -3/+20	V
Continuous Drain Current $V_{GS} = 20\text{V}$, $T_C = 25\text{ }^\circ\text{C}$ $V_{GS} = 20\text{V}$, $T_C = 100\text{ }^\circ\text{C}$	I_D	42.9 32.2	A
Power Dissipation $T_C = 25\text{ }^\circ\text{C}$ $T_C = 110\text{ }^\circ\text{C}$	P_{tot}	247 110	W
Operating Junction Range	T_J	-55 to +175	$^\circ\text{C}$
Storage Temperature Range	T_{stg}	-55 to +150	$^\circ\text{C}$
Soldering Temperature 1.6mm (0.063") from case for 10s	T_L	260	$^\circ\text{C}$
Mounting Torque, M3 Screw	M	1	Nm



Thermal Characteristics

Parameter	Symbol	Test Condition	Value			Unit
			min.	typ.	max.	
Thermal Resistance, junction-case	$R_{th(j-c)}$		-	0.6	-	°C/W

Electrical Characteristics (at $T_j = 25^\circ\text{C}$, unless otherwise specified)

Static Characteristics

Parameter	Symbol	Test Condition	Value			Unit
			min.	typ.	max.	
Drain-Source Breakdown Voltage	$V_{(BR)DSS}$	$V_{GS} = 0V, I_D = 100\mu A$	1200	-	-	V
Zero Gate Voltage Drain Current	I_{DSS}	$V_{DS} = 1200V, V_{GS} = 0V$ $T_j = 25^\circ\text{C}$ $T_j = 175^\circ\text{C}$	- -	0.07 9.7	100 -	μA
Gate-Source Leakage Current	I_{GSS}	$V_{GS} = 22V, V_{DS} = 0V$ $V_{GS} = -8V, V_{DS} = 0V$	- -	- -	100 100	nA
Gate-Source Threshold Voltage	$V_{GS(th)}$	$V_{DS} = V_{GS}, I_D = 5mA$ $T_j = 25^\circ\text{C}$ $T_j = 175^\circ\text{C}$	2 -	3.6 2.6	- -	V
Drain-Source On-State Resistance	$R_{DS(on)}$	$V_{GS} = 20V, I_D = 20A$ $T_j = 25^\circ\text{C}$ $T_j = 175^\circ\text{C}$	- -	80 112	100 -	m Ω
Transconductance	g_{fs}	$V_{DS} = 20V, I_D = 20A$ $T_j = 25^\circ\text{C}$ $T_j = 175^\circ\text{C}$	- -	6.7 7.3	- -	S
Internal Gate Resistance	$R_{G(int)}$	$f = 1MHz, V_{AC} = 15mV$	-	2	-	Ω



Dynamic Characteristics

Parameter	Symbol	Test Condition	Value			Unit
			min.	typ.	max.	
Input Capacitance	C_{iss}	$V_{DS} = 800V, V_{GS} = 0V$ $f = 1MHz, V_{AC} = 25mV$	-	2289	-	pF
Output Capacitance	C_{oss}		-	141	-	
Reverse Transfer Capacitance	C_{rss}		-	10.3	-	
C_{oss} Stroed Energy	E_{oss}		-	87	-	μJ
Total Gate Charge	Q_G	$V_{DD} = 800V, I_D = 20A$ $V_{GS} = -3/20V, \text{turn-on pulse}$	-	86	-	nC
Gate to Source Charge	Q_{GS}		-	26	-	
Gate to Drain Charge	Q_{GD}		-	32	-	

Switching Characteristics

Parameter	Symbol	Test Condition	Value			Unit
			min.	typ.	max.	
Turn-on Delay Time	$t_{d(on)}$	$V_{DD} = 800V, I_D = 20A$ $V_{GS} = -3/20V, R_{G(ext)} = 4.7\Omega$ $L_\sigma = 100\mu H$	-	30.8	-	ns
Rise time	t_r		-	35.9	-	
Turn-off delay time	$t_{d(off)}$		-	29.9	-	
Fall Time	t_f		-	12.4	-	
Turn-on Switching Energy	E_{on}	Body diode at $V_{GS} = -3V$ Inductive load	-	520.8	-	μJ
Turn-off Switching Energy	E_{off}		-	88.3	-	
Total Switching Energy	E_{tot}		-	609.1	-	



Body Diode Characteristics

Parameter	Symbol	Test Condition	Value			Unit
			min.	typ.	max.	
Diode Forward Voltage	V_{SD}	$V_{GS} = -3V, I_{SD} = 20A,$ $T_J = 25^\circ C$ $T_J = 175^\circ C$	- -	3.78 3.36	-	V
Continuous Diode Forward Current	I_{SD}	$V_{GS} = -3V, T_c = 25^\circ C$ $V_{GS} = -3V, T_c = 100^\circ C$	- -	- -	53 31	A
Revers Recovery Time	t_{rr}	$V_{DD} = 800V, I_b = 20A$	-	15.6	-	ns
Revers Recovery Charge	Q_{rr}	$V_{GS} = -3V, di/dt = 1000A/us$	-	75	-	nC
Peak Revers Recovery Current	I_{rm}	$T_J = 25^\circ C$	-	8.2	-	A



Typical Characteristics Curves

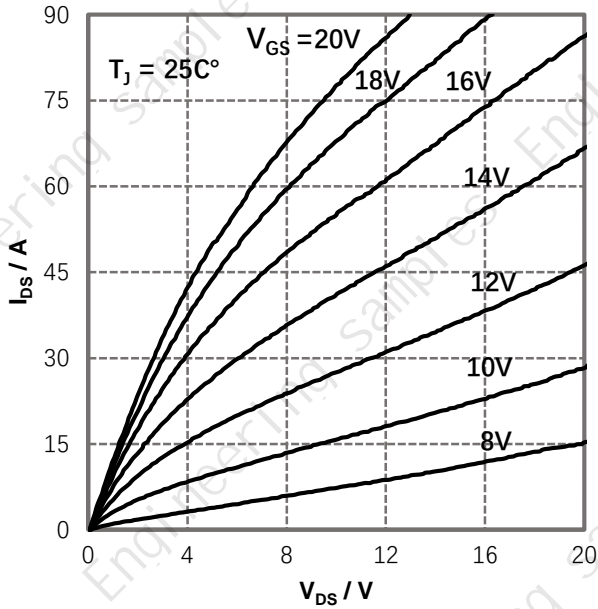

Figure 1. Output Characteristics $T_J=25^{\circ}\text{C}$

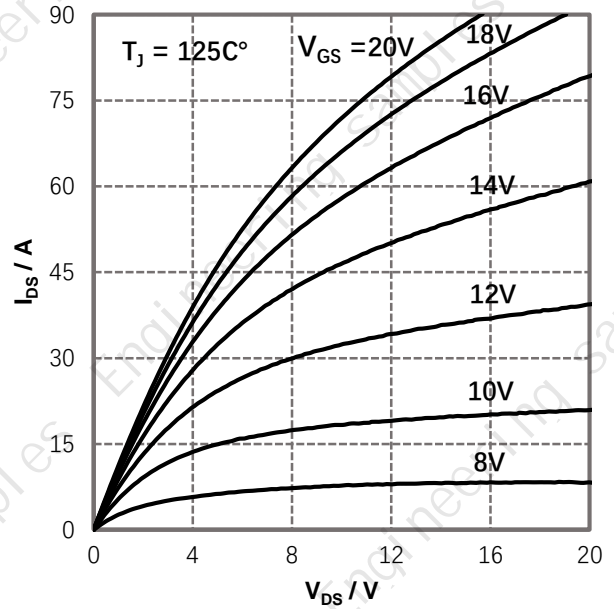

Figure 2. Output Characteristics $T_J=125^{\circ}\text{C}$

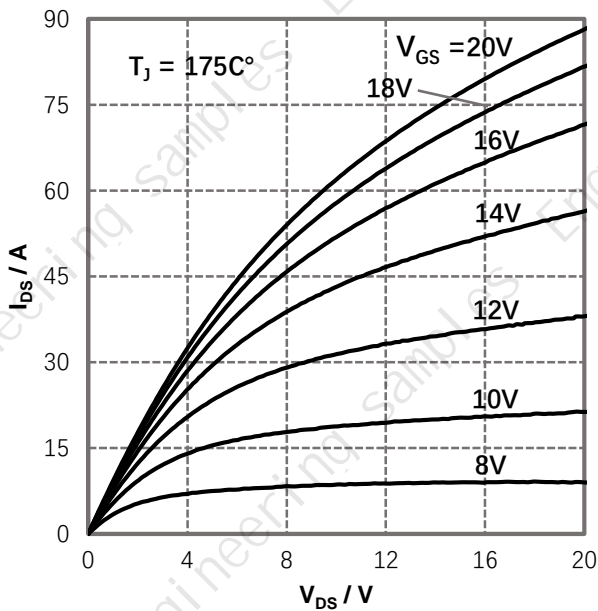

Figure 3. Output Characteristics $T_J=175^{\circ}\text{C}$

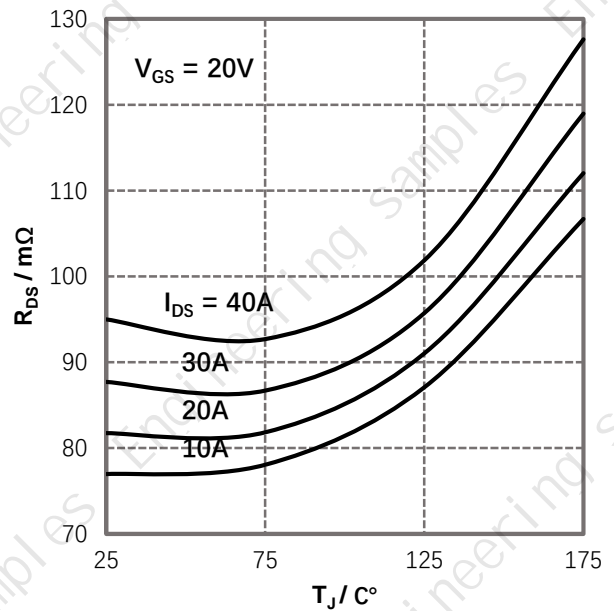

Figure 4. On-Resistance vs. Temperature For Various Drain Current



Typical Characteristics Curves

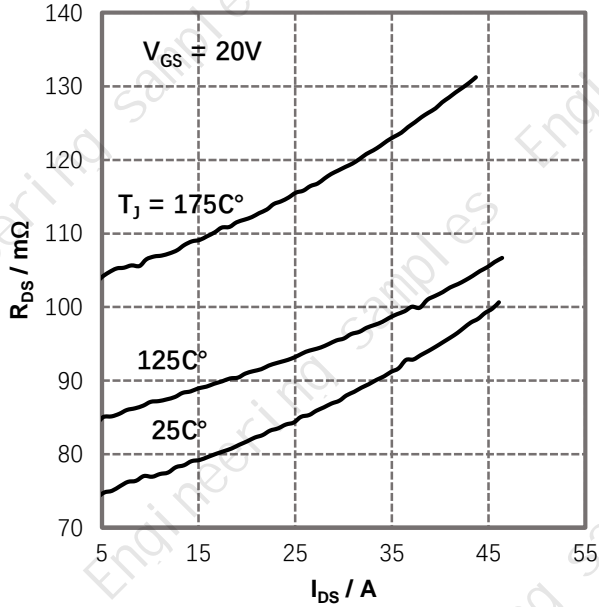

Figure 5. On-Resistance vs. Drain Current For Various Temperature

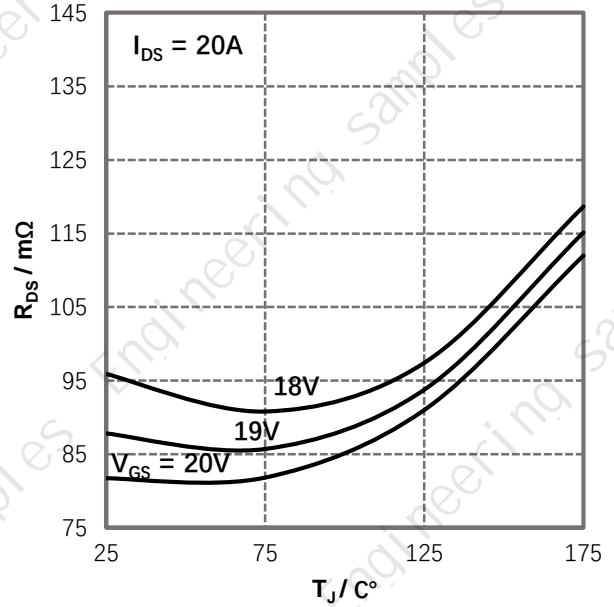

Figure 6. On-Resistance vs. Temperature For Various Gate Voltage

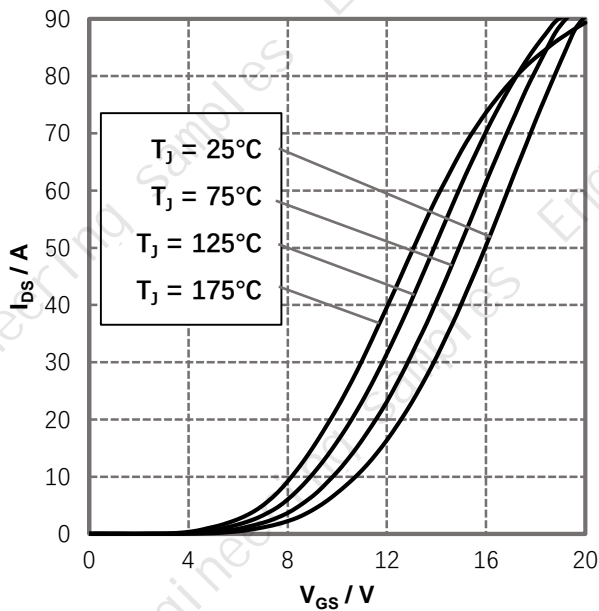

Figure 7. Transfer Characteristics

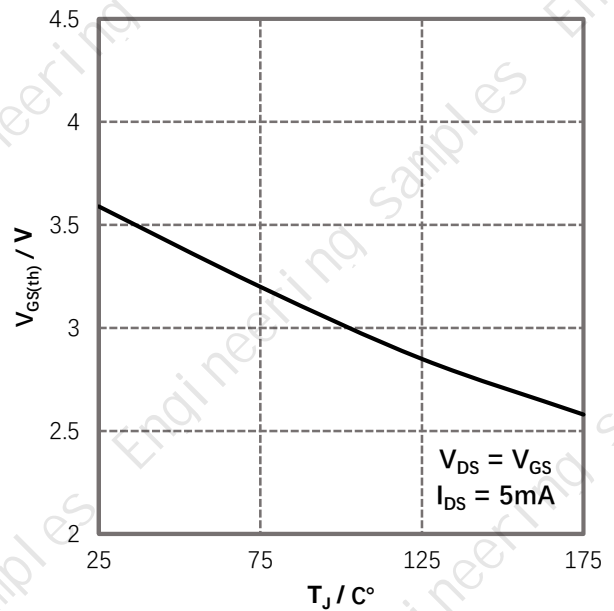

Figure 8. Threshold Voltage vs. Temperature



Typical Characteristics Curves

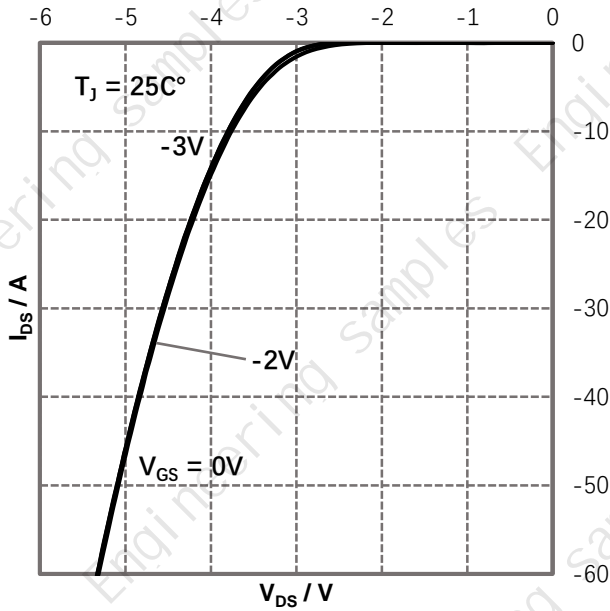

Figure 9. Body Diode Characteristics $T_j=25^{\circ}\text{C}$

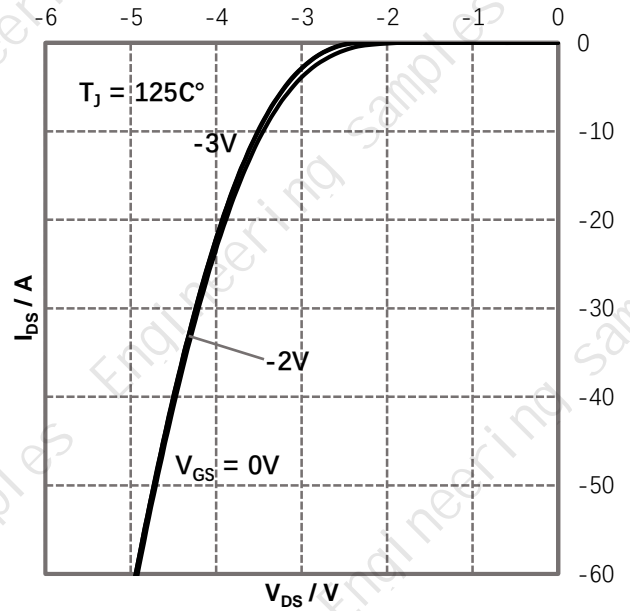

Figure 10. Body Diode Characteristics $T_j=-125^{\circ}\text{C}$

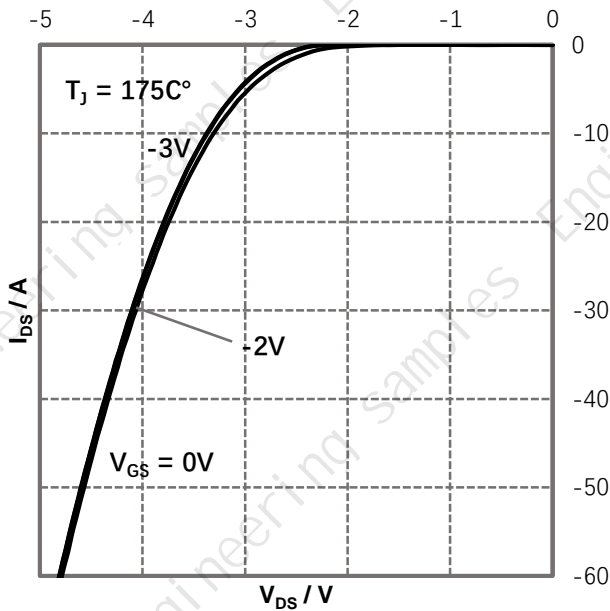

Figure 11. Body Diode Characteristics $T_j=-175^{\circ}\text{C}$

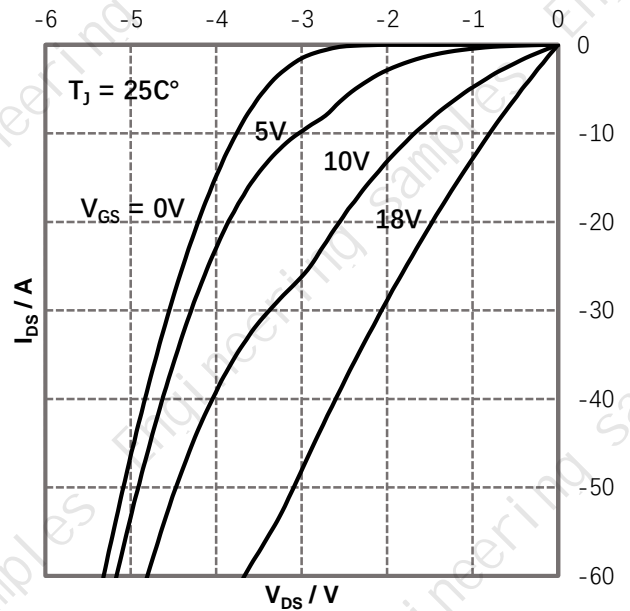

Figure 12. 3rd Quadrant Characteristics $T_j=-25^{\circ}\text{C}$



Typical Characteristics Curves

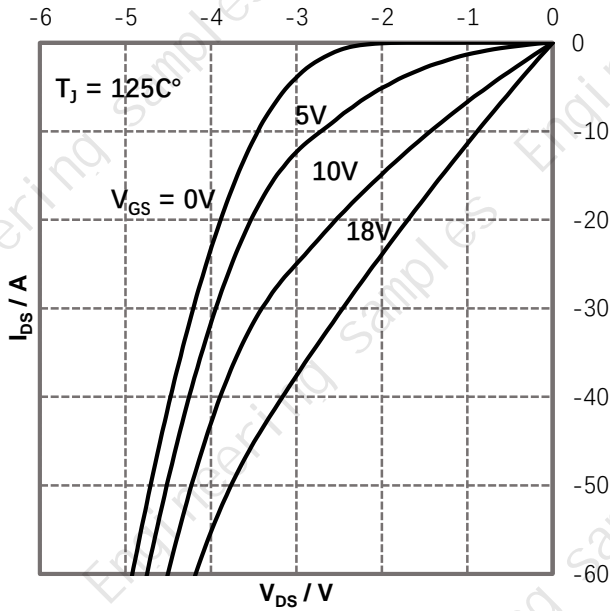

Figure 13. 3rd Quadrant Characteristics $T_j = -125^\circ\text{C}$

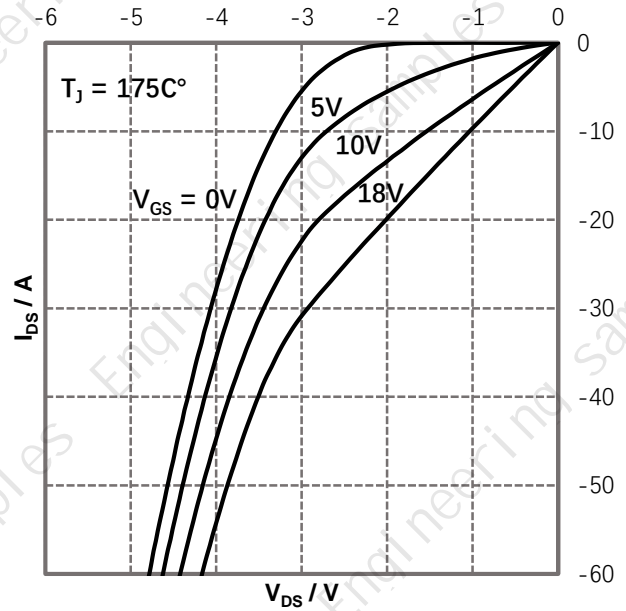

Figure 14. 3rd Quadrant Characteristics $T_j = -175^\circ\text{C}$

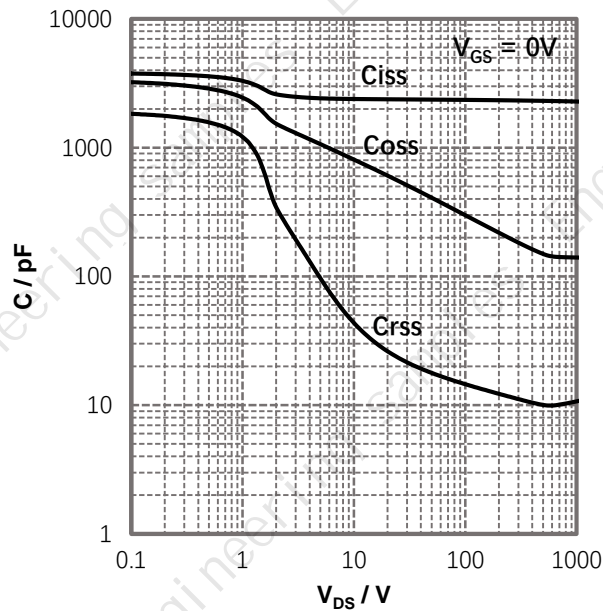

Figure 15. Capacitances vs. Drain-Source Voltage

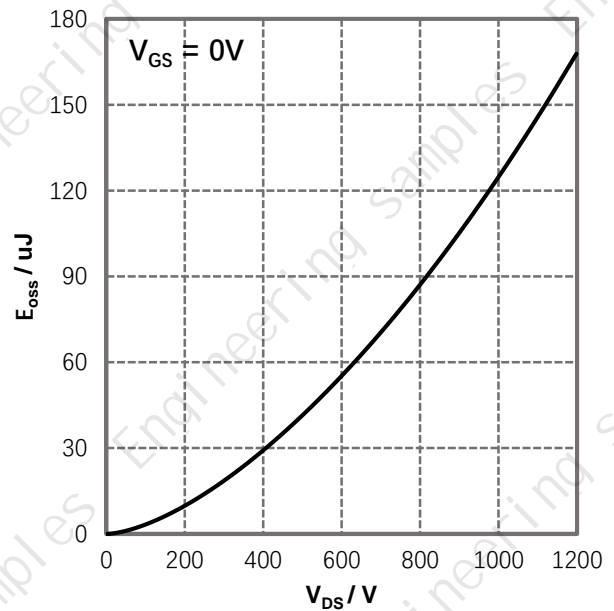

Figure 16. Output Capacitor Stored Energy



Typical Characteristics Curves

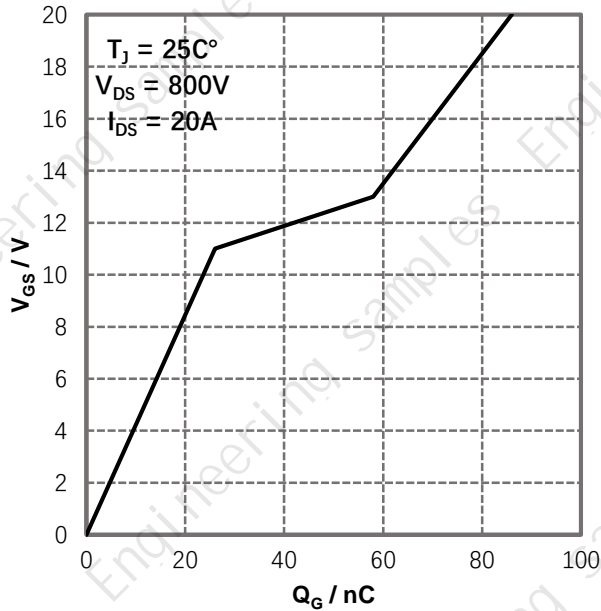

Figure 17. Gate Charge Characteristics

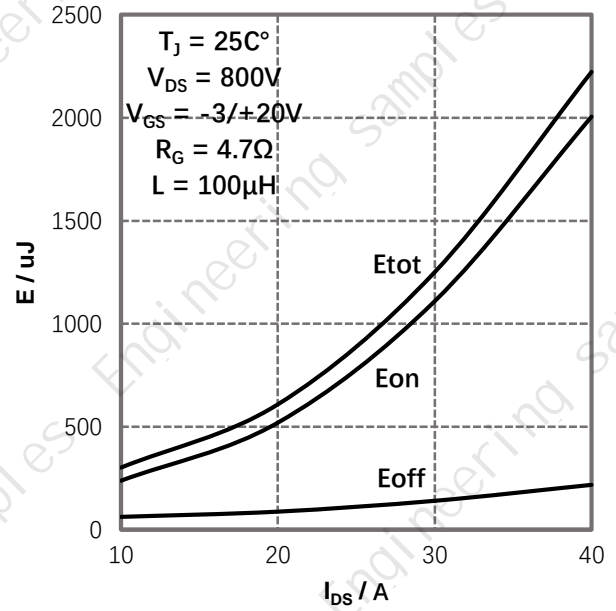

Figure 18. Switching Energy vs. Drain Current

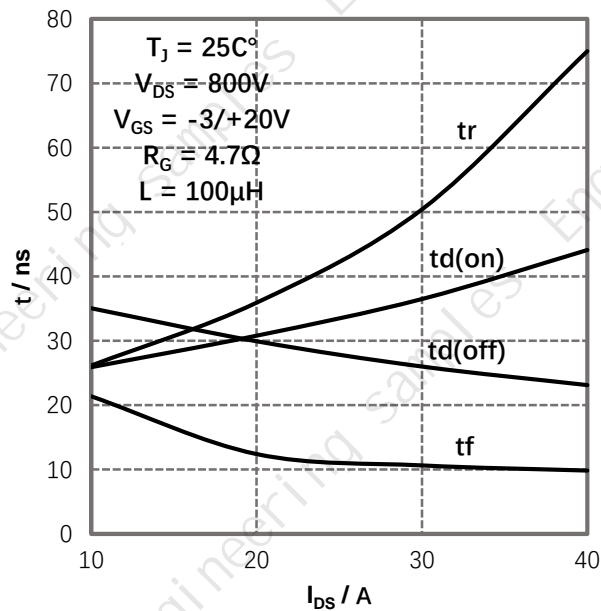

Figure 19. Switching Time vs. Drain Current

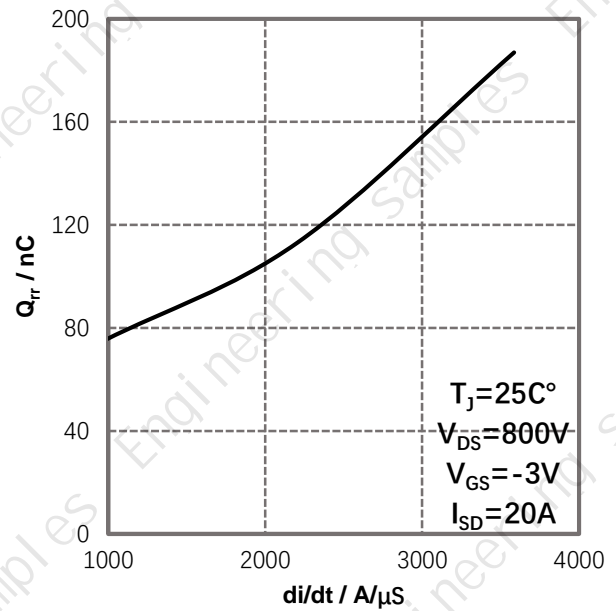

Figure 20. Reverse Recovery Charge vs. di/dt



Typical Characteristics Curves

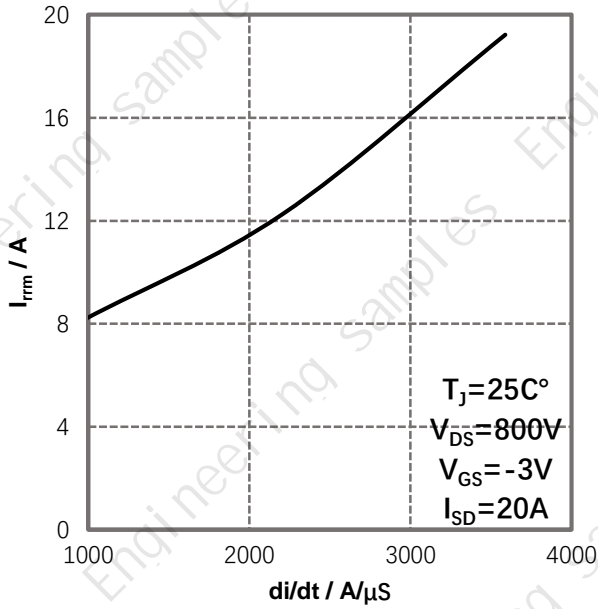

Figure 21. Reverse Recovery Current vs. di/dt

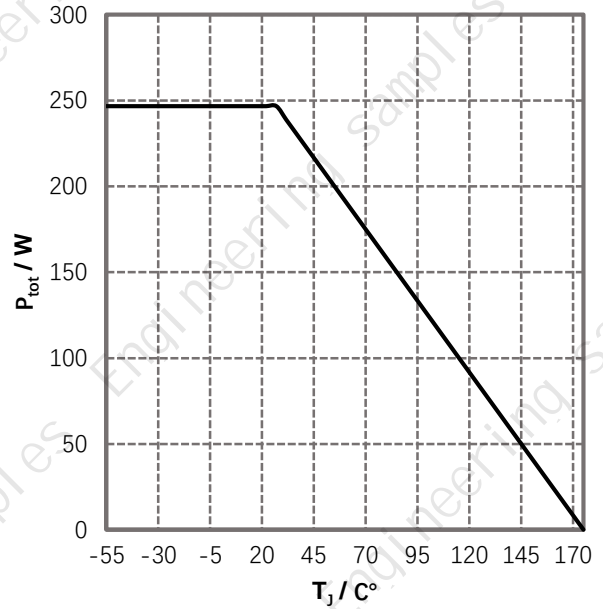

Figure 22. Power Dissipation Derating

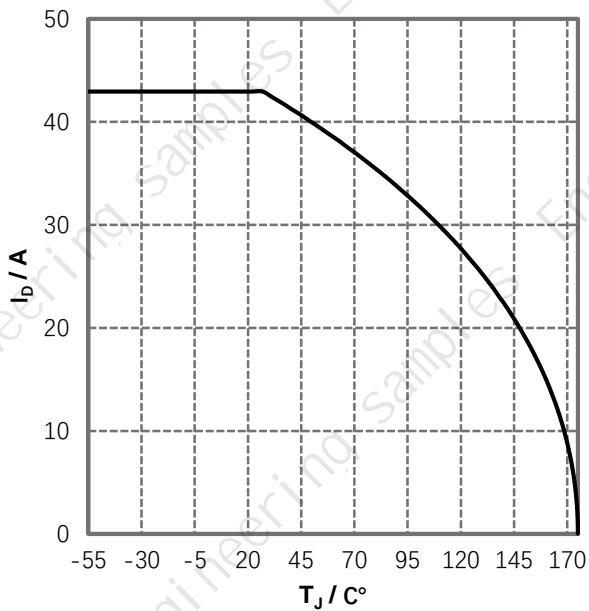

Figure 23. Continuous Drain Current Derating

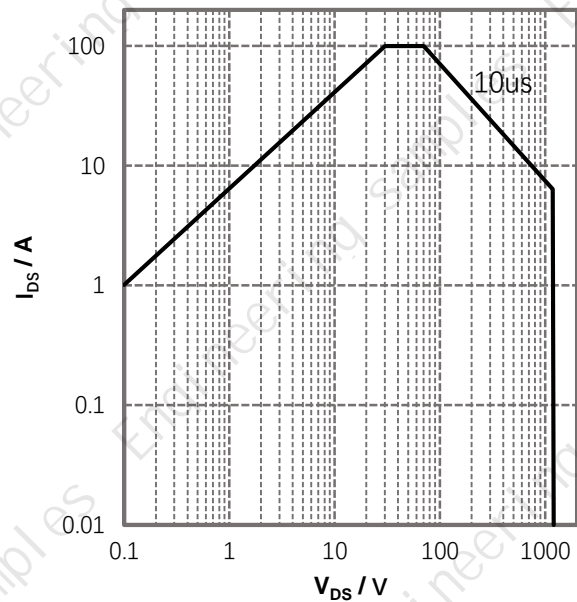
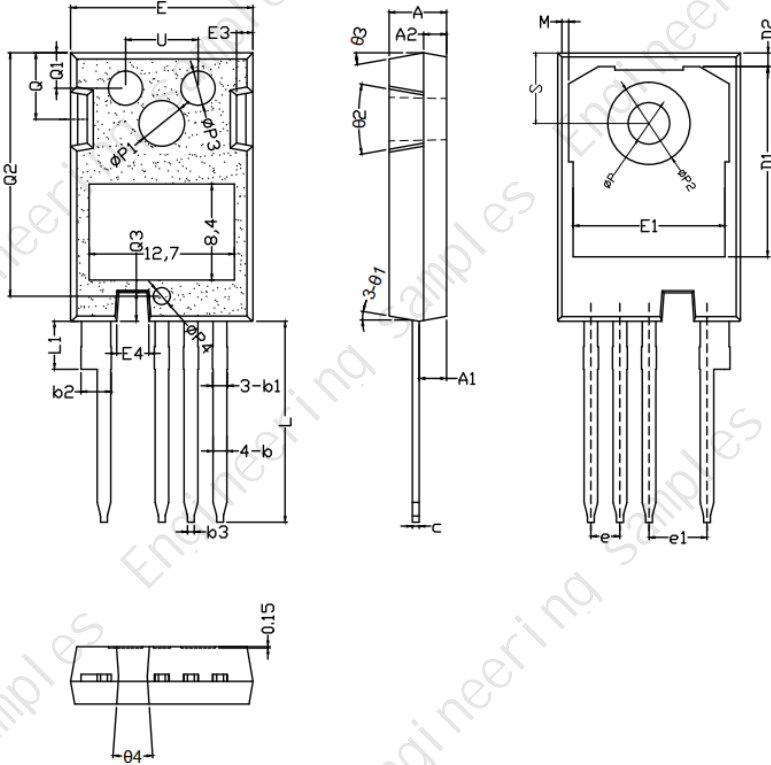

Figure 24. Safe Operating Area



Package Dimensions * is the key control dimension



SYMBOL	mm		
	MIN	NOM	MAX
*A	4.83	5.02	5.21
*A1	2.29	2.42	2.54
A2	1.91	2.00	2.16
*b	1.07	1.20	1.33
*b1	1.07	1.23	1.40
*b2	2.39	2.67	2.94
b3	0.45	0.60	0.75
*c	0.55	0.60	0.68
*D	23.30	23.45	23.60
D1	16.35	16.65	16.95
D2	0.95	1.19	1.25
*E	15.75	15.94	16.13
E1	13.00	13.25	13.45
E2	4.20	4.60	5.00
E3	1.00	1.45	1.90
E4	2.40	2.80	3.20
*e	2.50	2.54	2.58
*e1	5.03	5.08	5.13
*L	17.27	17.57	17.82
*L1	-	-	4.37
M	0.40	0.60	0.80
*ØP	3.51	3.61	3.71
ØP1	3.80	4.00	4.20
ØP2	7.03	7.18	7.33
ØP3	2.80	3.00	3.20
ØP4	1.30	1.50	1.70
Q	5.49	5.79	6.00
Q1	2.80	3.10	3.40
Q2	19.95	21.25	21.55
Q3	2.35	2.50	2.65
S	6.04	6.17	6.30
U	6.05	6.35	6.55
Ø1	6°	10°	13°
Ø2	16°	20°	24°
Ø3	6°	10°	13°
Ø4	5°	8°	11°

Ordering Information

Part Number	Marking	Package	Packaging Mode
G1M080120N	G1M080120N	TO-247-4L	30pcs / Tube



Notes

- Global Power Technology reserves the right to change or modify any of the products and their inherent physical and technical specifications without prior notice. Global Power Technology assumes no responsibility or liability for any errors or inaccuracies within.
- The information given in this document shall in no event be regarded as a guarantee of conditions or characteristics.

Related Links

- Global Power Technology Website: <http://www.globalpowertech.cn/>
- GPT online store is now open! you can place an order directly online, buy it easily, and send it directly from the factory! For more detailed product, price information and coupon activities, please log in to GPT online store: <http://sc.globalpowertech.cn/>

