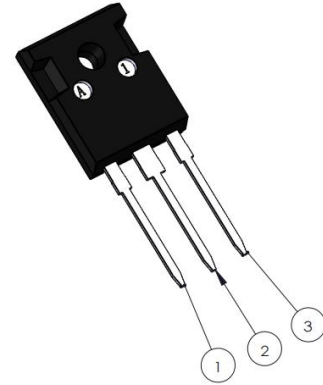

Description

Silicon Carbide (SiC) MOSFET use a completely new technology that provide superior switching performance and higher reliability compared to Silicon. In addition, the low ON resistance and compact chip size ensure low capacitance and gate charge. Consequently, system benefits include highest efficiency, faster operating frequency, increased power density, reduced EMI, and reduced system size.

Features

- High Speed Switching with Low Capacitances
- AST Technology with 12V Gate Drive
- Lower Q_G and Device Capacitances(C_{oss}, C_{rss})
- Body Diode with Low V_F and Low Q_{RR}
- Faster and More Efficient Switching
- ROHS Compliant, Halogen free

Application

- Solar String Inverter and Central Inverter
- UPS
- Switch Mode Power Supplies
- Power Factor Correction Modules
- Battery Charging
- Auxiliary Power Supply
- High Voltage Converter

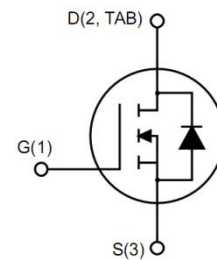
Ordering Information

Part Number	Marking	Package	Packaging
A3G5N1700MT3	A3G5N1700MT3	TO-247-3	Tube

Absolute Maximum Ratings(Tc=25°C)

Symbol	Parameter	Value	Unit
V _{DS}	Drain-Source Voltage	1700	V
I _D	Drain Current(continuous)at Tc=25°C	5	A
I _D	Drain Current(continuous)at Tc=100°C	3	A
I _{DM}	Drain Current (pulsed)	10	A
V _{GS}	Gate-Source Voltage	-5/+15	V
P _D	Power Dissipation T _C = 25°C	60	W
T _J , T _{stg}	Junction and Storage Temperature Range	-55 to +175	°C

Electrical Characteristics(T_J = 25°C unless otherwise specified)
Typical Performance-Static

Symbol	Parameter	Test Conditions	Min.	Typ.	Max.	Unit
BV _{DS}	Drain-source Breakdown Voltage	I _D =100uA, V _{GS} =0V	1700			V
I _{DSS}	Zero Gate Voltage Drain Current	V _{DS} =1700V, V _{GS} =0V, T _J =25°C			100	uA
I _{GSS}	Gate-body Leakage Current	V _{DS} =0V ; V _{GS} =-5 to 15V			100	nA
V _{GS(th)}	Gate Threshold Voltage	V _{DS} = V _{GS} , I _D =1mA	1.5	2	3	V
V _{GSon}	Recommended turn-on Voltage	Static		12		V
V _{GSoff}	Recommended turn-off Voltage			-3		V
R _{DS(on)}	Static Drain-source On Resistance	V _{GS} =12V, I _D =2A		750	1000	mΩ
		V _{GS} =12V, I _D =2A T _J =175°C		1350		mΩ

Typical Performance-Dynamic

Symbol	Parameter	Test Conditions	Min.	Typ.	Max.	Unit	
C _{iss}	Input Capacitance	V _{DS} =1000V, f=1MHz, V _{GS} =0V V _{AC} =25mV		200		pF	
C _{oss}	Output Capacitance			6		pF	
C _{rss}	Reverse Transfer Capacitance			1		pF	
g _{fs}	Transconductance	V _{DS} =10V, I _D =2A		1		S	
E _{OSS}	C _{OSS} Stored Energy	V _{DS} =1000V, f=1MHz		3		μJ	
E _{ON}	Turn-On Energy (Body Diode)	V _{DS} =1200V, V _{GS} =-3/12V, I _D =2A, L=1mH T _J =175°C		64		μJ	
E _{OFF}	Turn-Off Energy (Body Diode)		R _{ext} =25Ω		15		μJ
Q _g	Total Gate Charge	V _{DS} =1200V, V _{GS} =-3V/12V, I _D =2A		8		nC	
Q _{gs}	Gate-source Charge			1.5		nC	
Q _{gd}	Gate-Drain Charge			3		nC	
t _{d(on)}	Turn-on Delay Time	V _{DS} =1200V, V _{GS} =-3V/12V, I _D =2A, L=1mH		10		ns	
t _r	Rise Time			7		ns	
t _{d(off)}	Turn-off Delay Time		R _{ext} =25Ω		8		ns
t _f	Fall Time				6		ns

Typical Performance-Reverse Diode(T_J = 25°C unless otherwise specified)

Symbol	Parameter	Test Conditions	Min.	Typ.	Max.	Unit
V _{FSD}	Forward Voltage	V _{GS} =0V, I _F =1A, T _J =25°C		3.5	6	V
		V _{GS} =0V, I _F =1A, T _J =175°C		3	6	V
I _S	Continuous Diode Forward Current	V _{GS} =0V, T _C =25°C		5		A

Thermal Characteristics

Symbol	Parameter	Value.	Unit
R _{θJC}	Thermal Resistance, Junction-to-Case	2.5	°C/W
R _{θJA}	Thermal Resistance, Junction-to-Ambient	40	°C/W

The values are based on the junction-to case thermal impedance which is measured with the device mounted to a large heat sink assuming maximum junction temperature of T_J(max)=175°C

Electrical Characteristics

Fig1. Output characteristics ($T_J = 25^\circ\text{C}$)

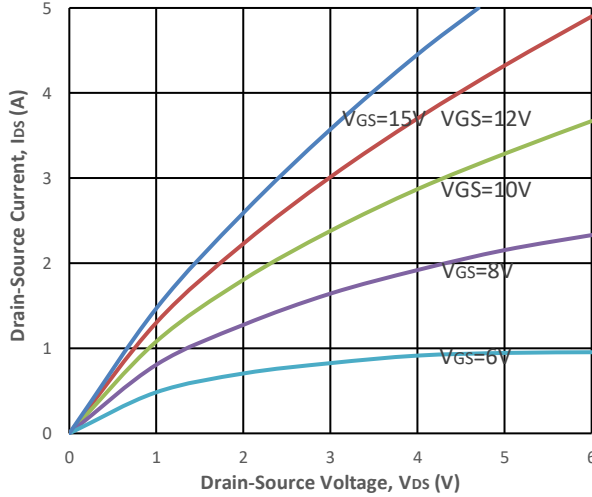

Fig2. Output characteristics ($T_J = 175^\circ\text{C}$)

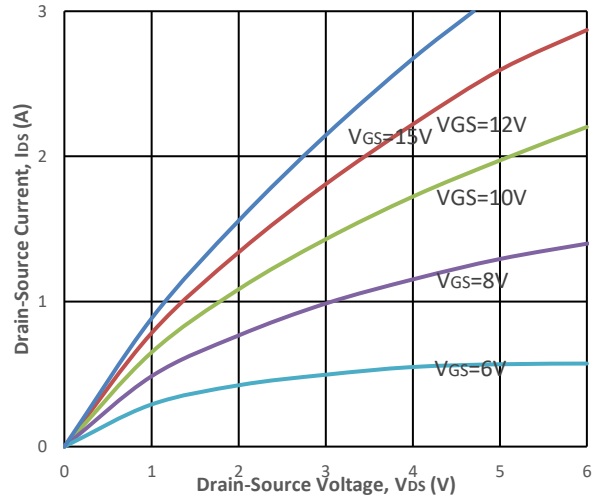

Fig3. Normalized On-Resistance vs. Temperature

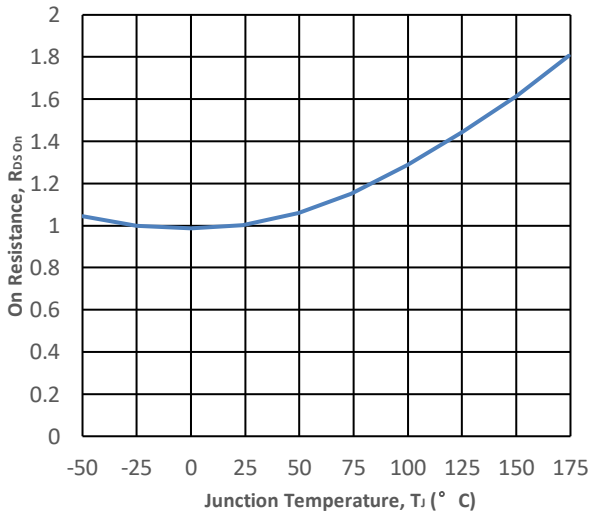

Fig4. On-Resistance vs. Temperature

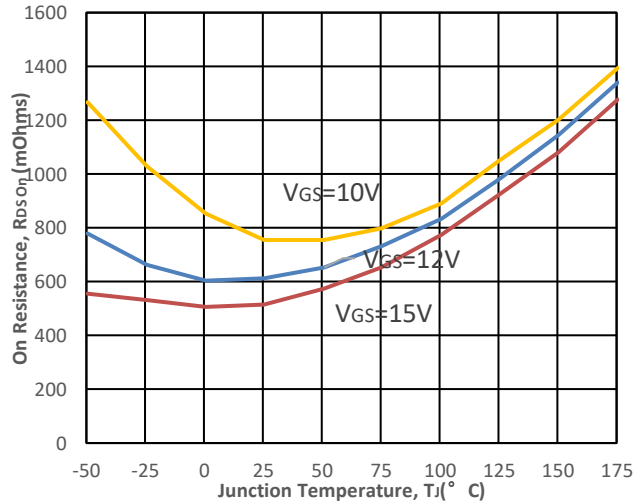

Fig5. Transfer Characteristic

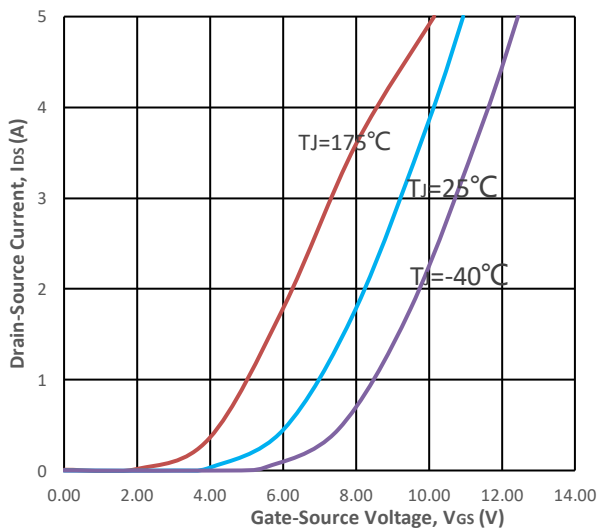

Fig6. Body Diode Characteristic at 25°C

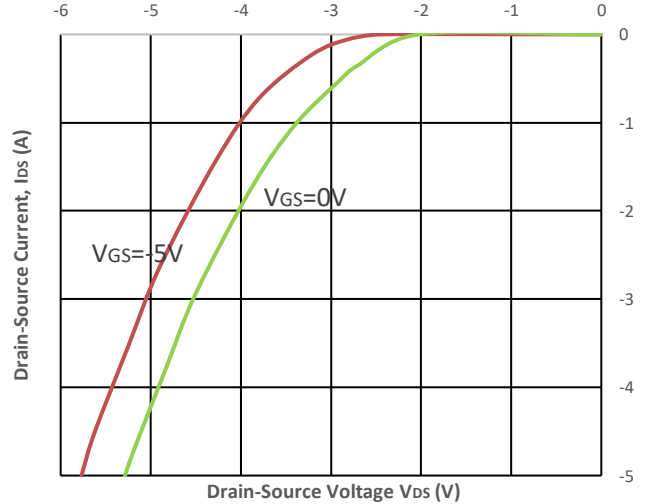

Fig7. Threshold Voltage vs. Temperature

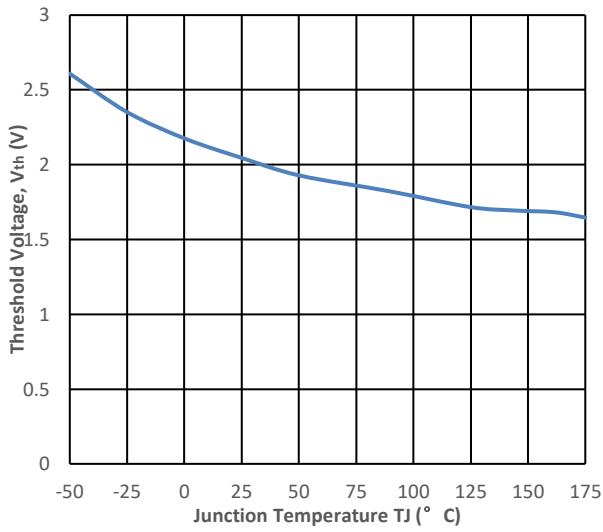

Fig8. Gate Charge Characteristics

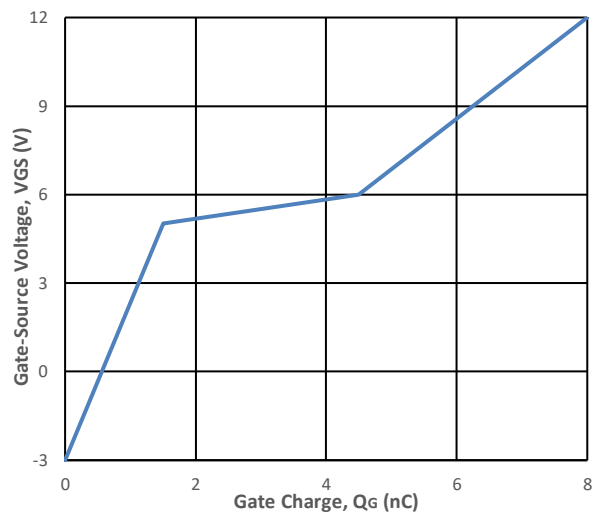

Fig9. 3rd Quadrant Characteristic at 25 °C

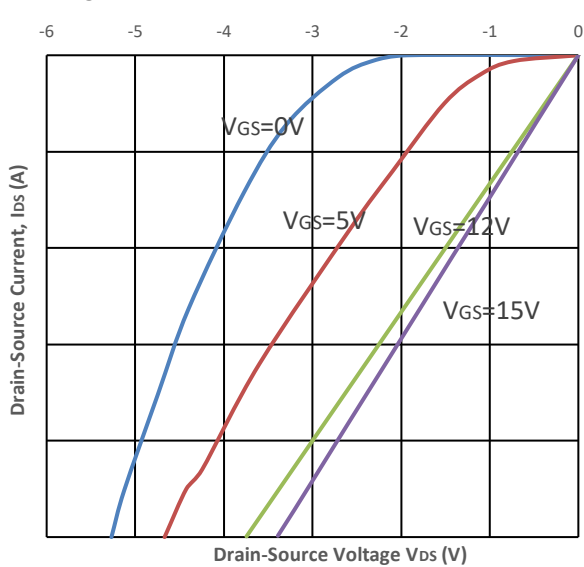

Fig11. Capacitances vs. Drain-Source

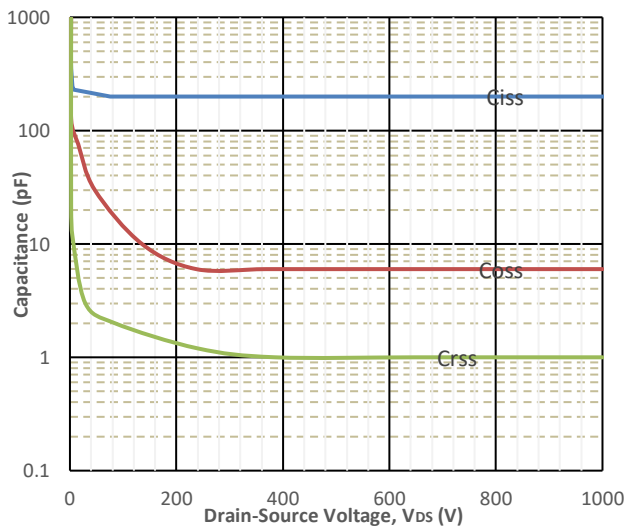

Fig10. Output Capacitor Stored Energy

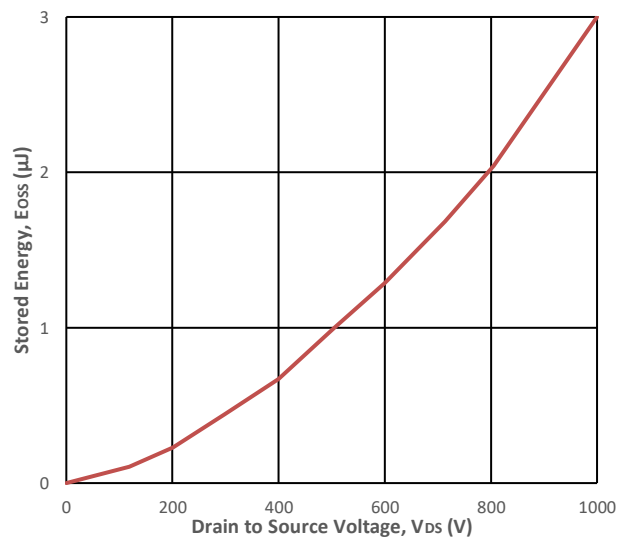

Fig12. Max Power Dissipation Derating Vs T_c

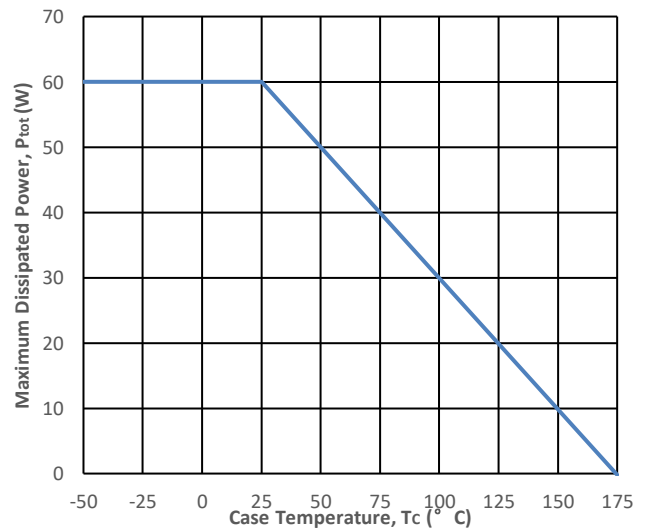

Fig13. Switching Energy vs. Drain Current

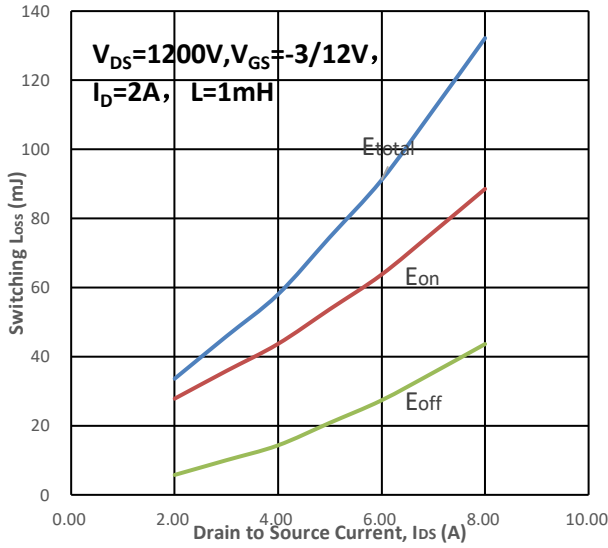

Fig14. Switching Energy vs. $R_{G(ext)}$

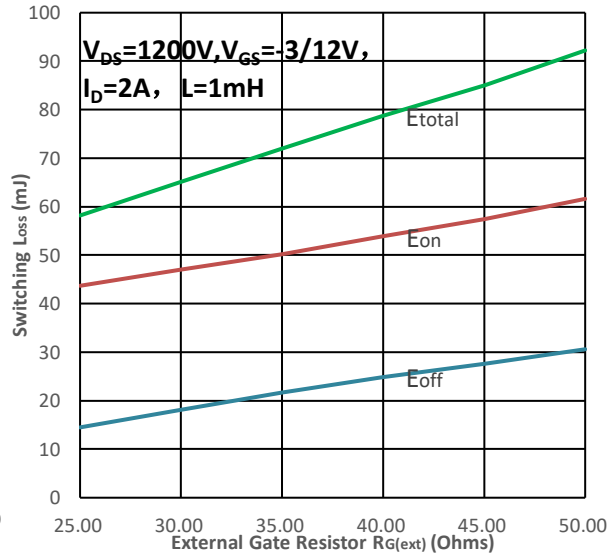

Fig15. Switching Energy vs. Temperature

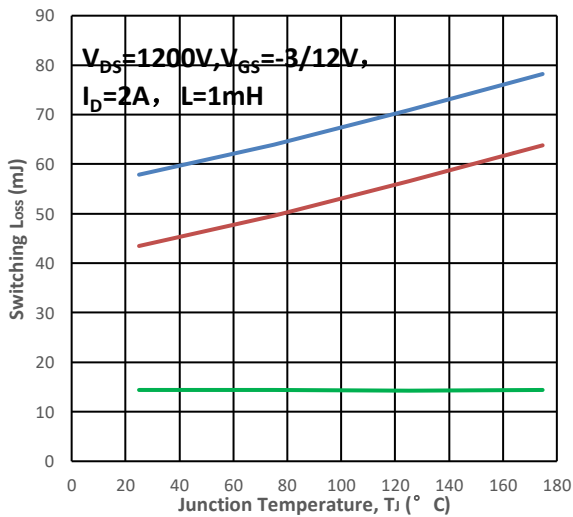

Fig16. Switching Times vs. $R_{G(ext)}$

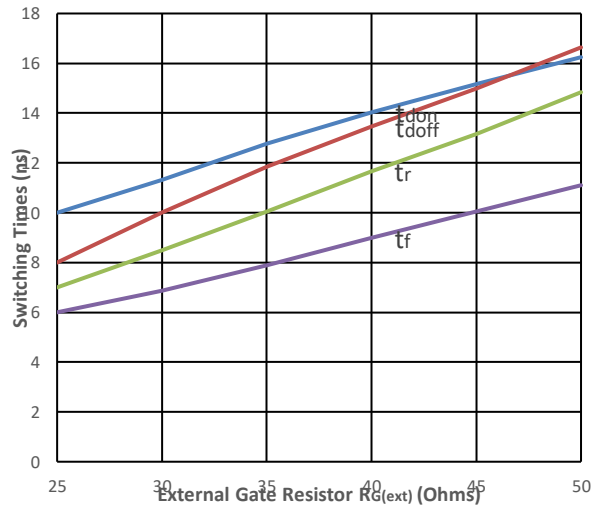

Fig17. Transient Thermal Impedance

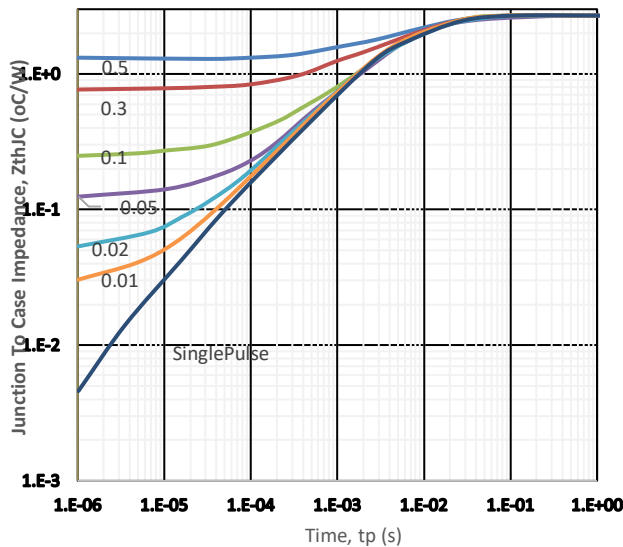
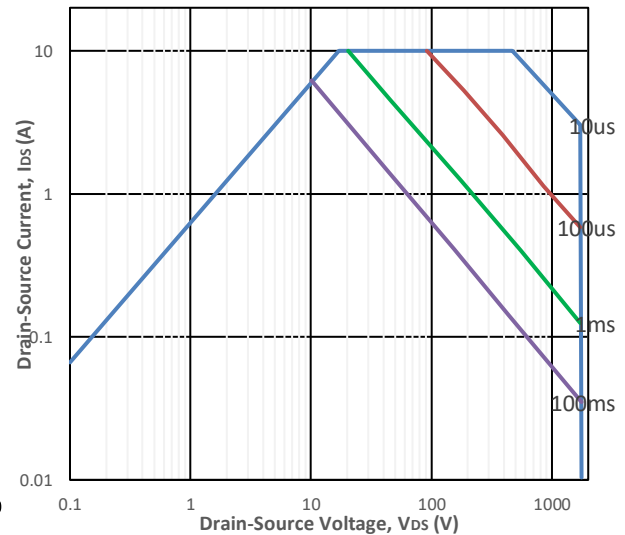
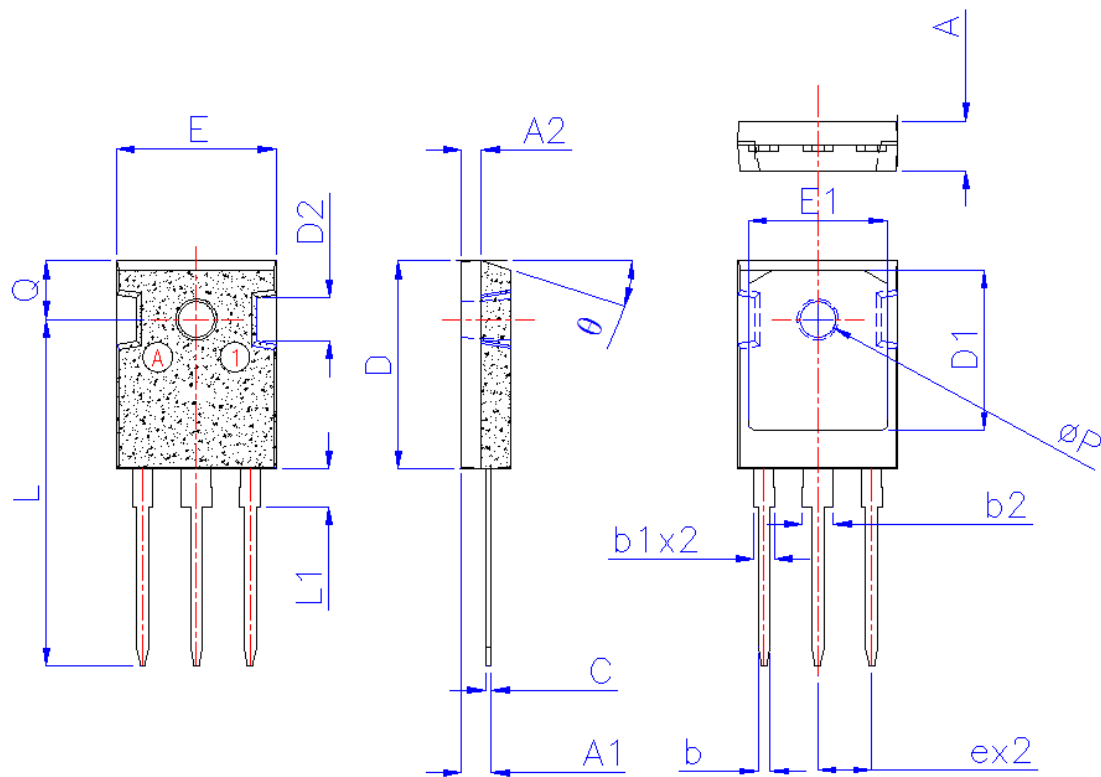

Fig18. Safe Operating Area



Package Drawing:



Dimensions (UNIT: mm)

SYMBOLS	DIMENSIONS IN MILLIMETERS			DIMENSIONS IN INCHES		
	MIN	TYPE	MAX	MIN	TYPE	MAX
A	4.80	5.00	5.20	0.189	0.197	0.205
A1	2.85	3.00	3.15	0.112	0.118	0.124
b	1.16	1.22	1.27	0.046	0.048	0.050
b1	2.03	2.06	2.10	0.080	0.081	0.083
b2	3.03	3.06	3.10	0.119	0.120	0.122
C	0.55	0.60	0.65	0.022	0.024	0.026
D	20.80	21.00	21.20	0.819	0.827	0.835
D1	15.94	16.24	16.54	0.628	0.639	0.651
D2	4.30 BSC			0.169 BSC		
e	5.44 BSC			0.214 BSC		
E	15.95	16.15	16.35	0.628	0.636	0.644
E1	13.82	14.02	14.26	0.544	0.552	0.561
L	34.65	35.05	35.45	1.364	1.380	1.396
L1	-	-	3.86	-	-	0.152
Q	5.85	5.95	6.05	0.230	0.234	0.238
øP	3.45	3.60	3.75	0.136	0.142	0.148
θ	17.5°			0.689°		