

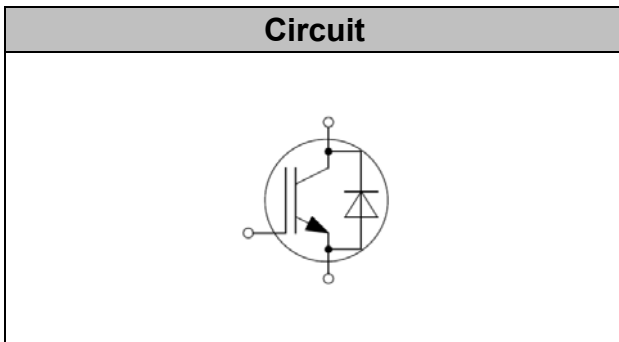

IGBT Descrete

V_{CE}	650	V
I_C	15	A
$V_{CE(SAT)} I_C=15A$	1.65	V



Applications

- Soft switching applications
- Airconditioning
- Motor drive inverter

Features

- High speed smooth switching device for hard & soft switching
- Maximum junction temperature 175°C
- Positive temperature coefficient
- High ruggedness, temperature stable
- Pb-free lead plating; RoHS compliant

Maximum Ratings

Parameter	Symbol	Value	Unit
Collector-Emitter Breakdown Voltage	V_{CE}	650	V
DC Collector Current, limited by T_{jmax} $T_C=25^\circ C$ value limited by bondwire $T_C=100^\circ C$	I_C	30 15	A
Diode Forward Current, limited by T_{jmax} $T_C=25^\circ C$ $T_C=100^\circ C$	I_F	30 15	A
Continuous Gate-Emitter Voltage	V_{GE}	± 20	V
Transient Gate-Emitter Voltage	V_{GE}	± 30	V
Turn off Safe Operating Area $V_{CE} \leq 650V$, $T_j \leq 150^\circ C$		60	A
Pulsed Collector Current, $V_{GE}=15V$, t_p limited by T_{jmax}	I_{CM}	60	A
Short Circuit Withstand Time, $V_{GE}=15V$, $V_{CE} \leq 400V$	T_{sc}	5	μs
Diode Pulsed Current, t_p limited by T_{jmax}	I_{Fpuls}	60	A
Power Dissipation, $T_j=175^\circ C, T_C=25^\circ C$	P_{tot}	130	W



Operating Junction Temperature	T_j	-40...+175	°C
Storage Temperature	T_s	-55...+150	°C
Soldering Temperature, wave soldering 1.6mm (0.063in.) from case for 10s		260	°C

Electrical Characteristics of the IGBT ($T_j=25^\circ\text{C}$ unless otherwise specified):

Parameter	Symbol	Conditions	Min.	Typ.	Max.	Unit
Static						
Collector-Emitter Breakdown Voltage	BV_{CES}	$V_{GE}=0V, I_C=250\mu A$	650		-	V
Gate Threshold Voltage	$V_{GE(th)}$	$V_{GE}=V_{CE}, I_C=250\mu A$	4.1	5.0	5.7	V
Collector-Emitter Saturation Voltage	$V_{CE(sat)}$	$V_{GE}=15V, I_C=15A$ $T_j=25^\circ\text{C}$, $T_j=125^\circ\text{C}$ $T_j=150^\circ\text{C}$		1.65 1.95 2.05	1.95	V
Zero Gate Voltage Collector Current	I_{CES}	$V_{CE}=650V, V_{GE}=0V$ $T_j=25^\circ\text{C}$, $T_j=150^\circ\text{C}$			0.25	mA
Gate-Emitter Leakage Current	I_{GES}	$V_{CE}=0V, V_{GE}=\pm 20V$			± 200	nA
Transconductance	g_{fs}	$V_{CE}=20V, I_C=15A$		10		S

Parameter	Symbol	Conditions	Min.	Typ.	Max.	Unit
Dynamic						
Input Capacitance	C_{ies}	$V_{CE}=25V, V_{GE}=0V,$ $f=1\text{MHz}$	-	0.99	-	nF
Output capacitance	C_{oes}		0.056			
Reverse Transfer Capacitance	C_{res}		-	0.03	-	
Gate Charge	Q_G	$V_{CC}=480V, I_C=15A,$ $V_{GE}=15V$	-	0.052	-	uC
Short circuit collector current	$I_{C(SC)}$	$V_{GE}=15V, t_{SC}\leq 5\mu s$ $V_{CC}=400V,$ $T_{j, start}=25^\circ\text{C}$	-	98	-	A



Electrical Characteristics of the Diode (T_j= 25°C unless otherwise specified):

Parameter	Symbol	Conditions	Min.	Typ.	Max.	Unit
Static						
Diode Forward Voltage	V _F	I _F = 15A T _j = 25°C, T _j = 125°C T _j = 150°C		1.70 1.65 1.65		V

Switching Characteristic, Inductive Load

Parameter	Symbol	Conditions	Min.	Typ.	Max.	Unit
Dynamic , at T_j= 25°C						
Turn-on Delay Time	t _{d(on)}	T _j =25°C V _{CC} = 400V, I _C =15A, V _{GE} =0/15V, R _g =12 Ω	-	15	-	ns
Rise Time	t _r		-	25	-	ns
Turn-on Energy	E _{on}		-	0.75	-	mJ
Turn-off Delay Time	t _{d(off)}		-	60	-	ns
Fall Time	t _f		-	46	-	ns
Turn-off Energy	E _{off}		-	0.1	-	mJ
Dynamic , at T_j= 125°C						
Turn-on Delay Time	t _{d(on)}	T _j =25°C V _{CC} = 400V, I _C =15A, V _{GE} =0/15V, R _g =12 Ω	-	24	-	ns
Rise Time	t _r		-	30	-	ns
Turn-on Energy	E _{on}		-	1.10	-	mJ
Turn-off Delay Time	t _{d(off)}		-	90	-	ns
Fall Time	t _f		-	54	-	ns
Turn-off Energy	E _{off}		-	0.15	-	mJ
Dynamic , at T_j= 150°C						
Turn-on Delay Time	t _{d(on)}	T _j =25°C V _{CC} = 400V, I _C =15A, V _{GE} =0/15V, R _g =12 Ω	-	26	-	ns
Rise Time	t _r		-	32	-	ns
Turn-on Energy	E _{on}		-	1.25	-	mJ
Turn-off Delay Time	t _{d(off)}		-	95	-	ns
Fall Time	t _f		-	58	-	ns
Turn-off Energy	E _{off}		-	0.18	-	mJ



Electrical Characteristics of the DIODE

Parameter	Symbol	Conditions	Min.	Typ.	Max.	Unit
Dynamic , at T_j= 25°C						
Reverse Recovery Current	I _{rr}	I _F =15A, V _R =300V, -di/dt= 200A/μs,	-	12	-	A
Reverse Recovery Charge	Q _{rr}		-	0.5	-	uC
Reverse Recovery Energy	E _{rec}		-	0.06		mJ
Dynamic , at T_j= 125°C						
Reverse Recovery Current	I _{rr}	I _F =15A, V _R =300V, -di/dt= 200A/μs,	-	15	-	A
Reverse Recovery Charge	Q _{rr}		-	0.9	-	uC
Reverse Recovery Energy	E _{rec}		-	0.12		mJ
Dynamic , at T_j= 150°C						
Reverse Recovery Current	I _{rr}	I _F =15A, V _R =300V, -di/dt= 200A/μs,	-	16	-	A
Reverse Recovery Charge	Q _{rr}		-	1.2	-	uC
Reverse Recovery Energy	E _{rec}		-	0.15		mJ

Thermal Resistance

Parameter	Symbol	Max. Value	Unit
IGBT Thermal Resistance, Junction - Case	R _{th(j-c)}	1.15	K/W
Diode Thermal Resistance, Junction - Case	R _{th(j-c)}	1.9	K/W
Thermal Resistance, Junction - Ambient	R _{th(j-a)}	60	K/W



Fig. 1 FBSOA characteristics

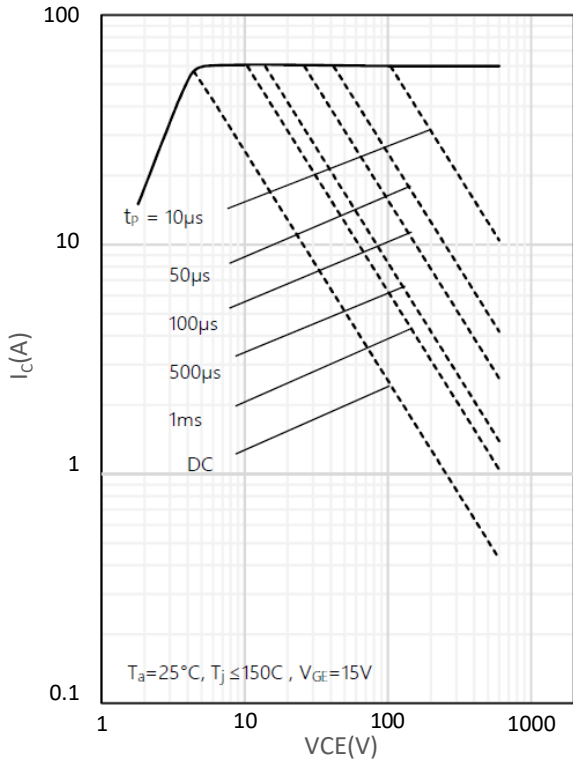

Fig. 2 Load Current vs. Frequency

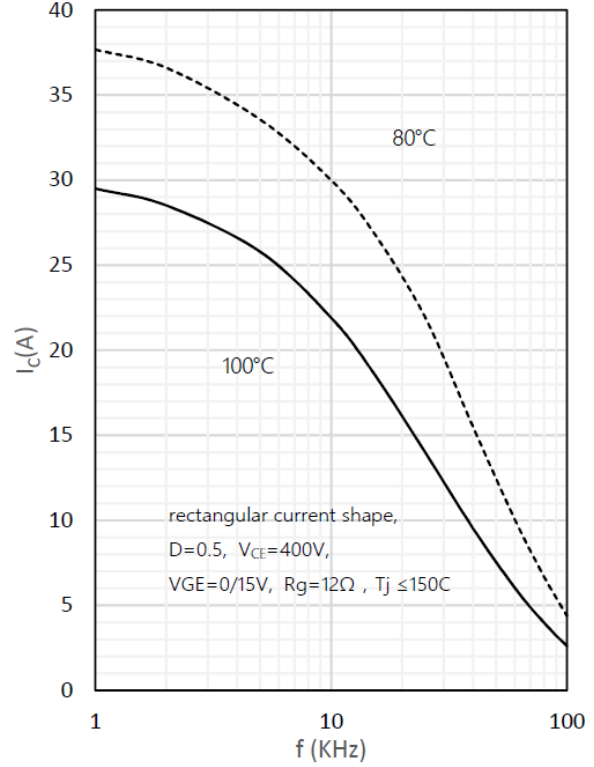

Fig. 3 Output characteristics

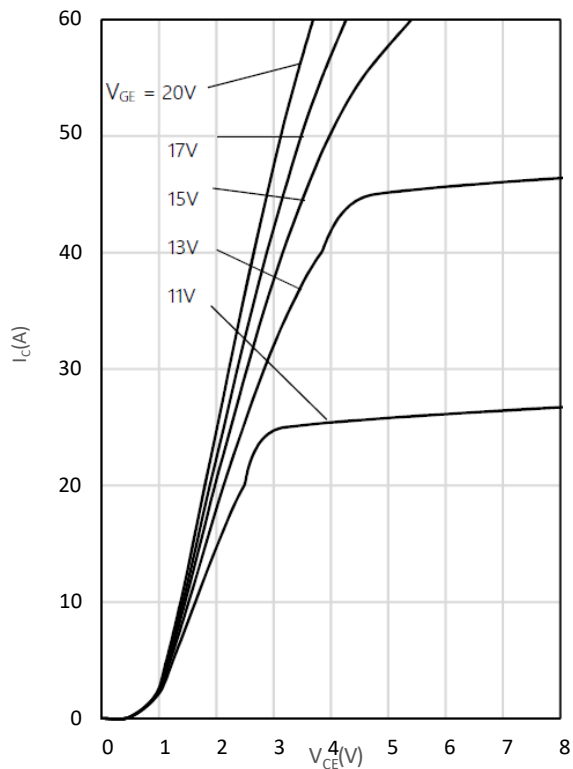
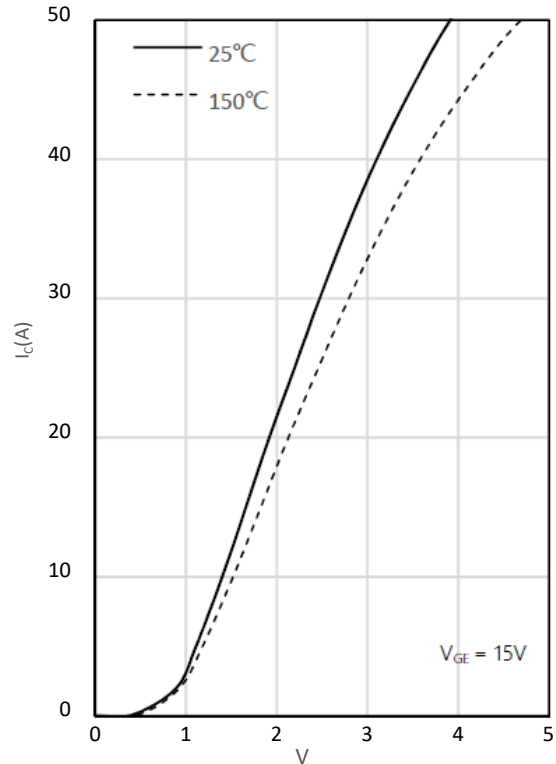

Fig. 4 Saturation voltage characteristics





$c_E(V)$

Fig. 5 Switching times vs. gate resistor

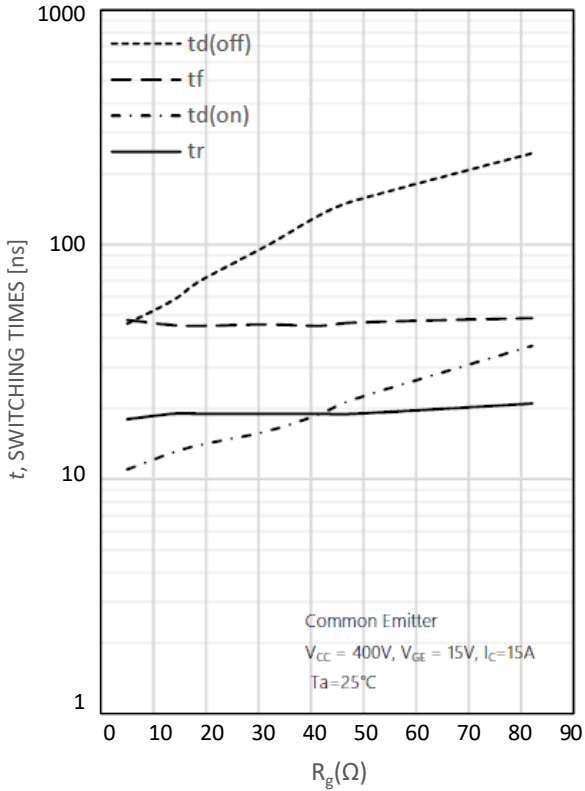

Fig. 6 Switching times vs. collector current

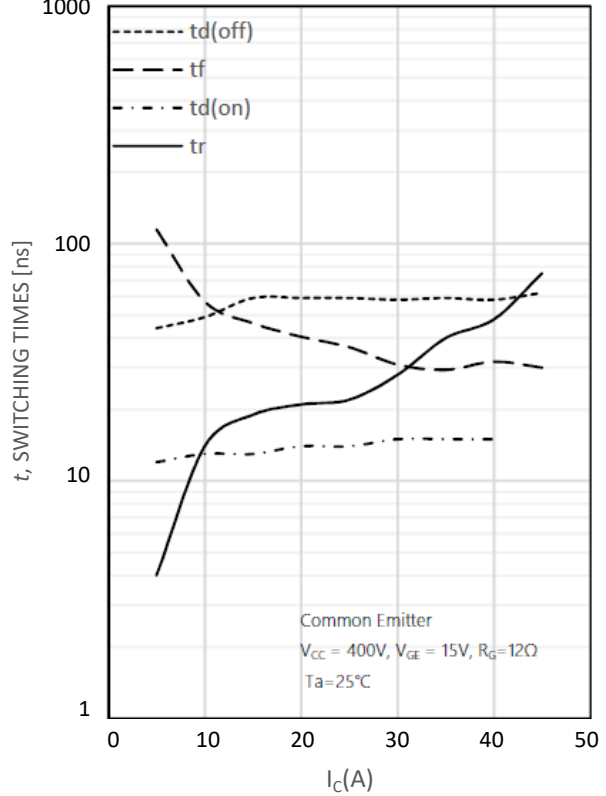

Fig. 7 Switching loss vs. gate resistor

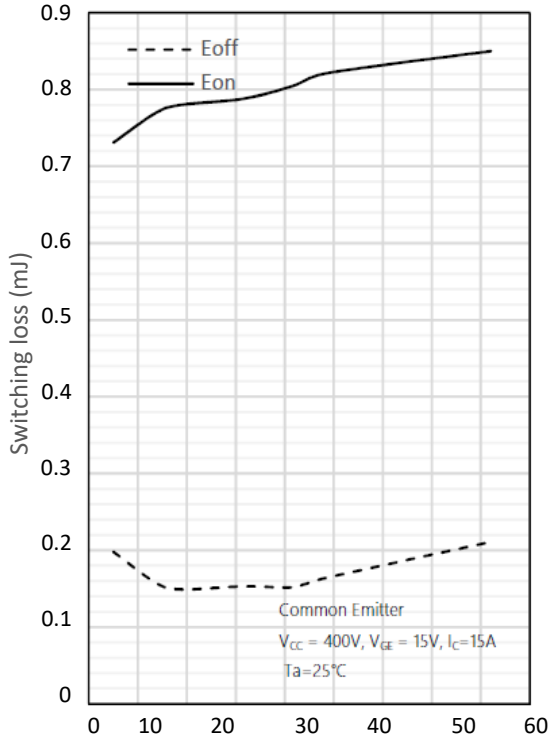
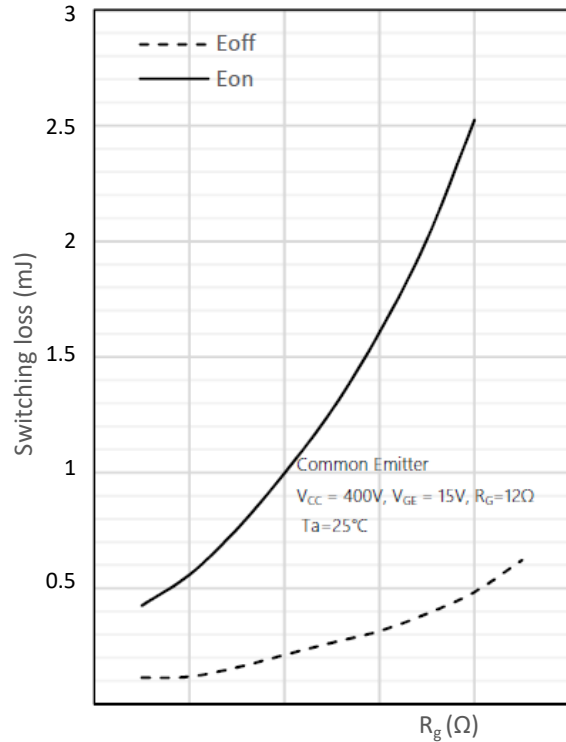

Fig. 8 Switching loss vs. collector current





0
0 10 20 30 40 50 I_c (A)

Fig. 9 Gate charge characteristics

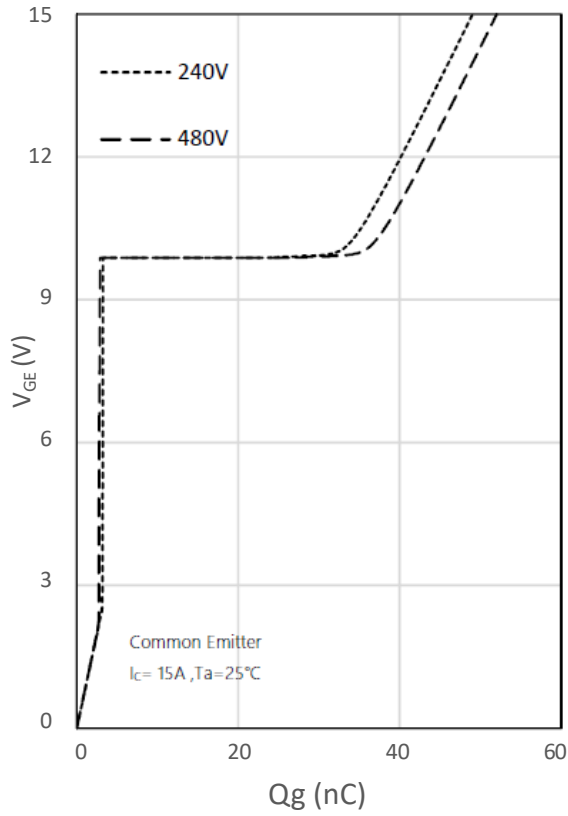
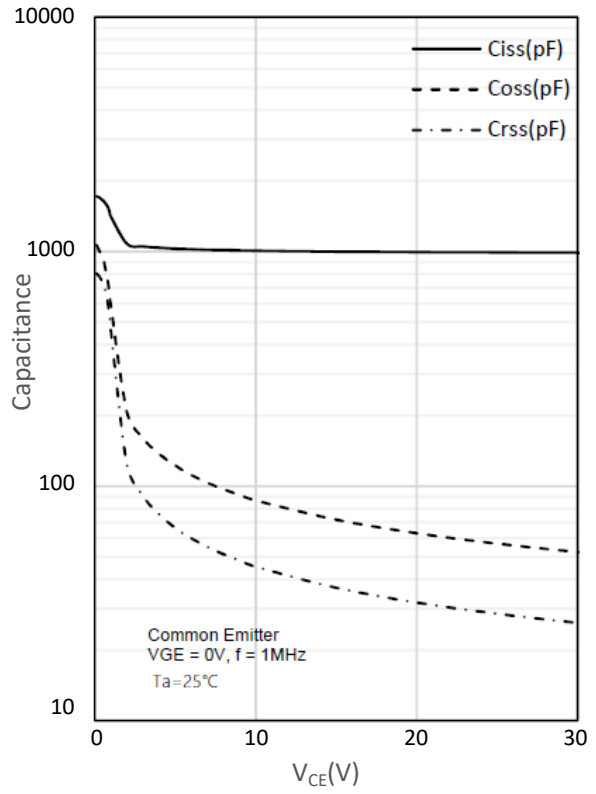
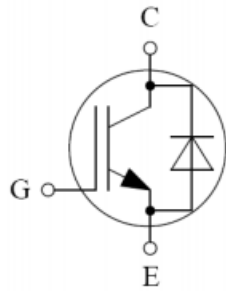

Fig. 10 Capacitance characteristics



● Circuit Diagram



● Package Outline Information

CASE: TO-220 package information

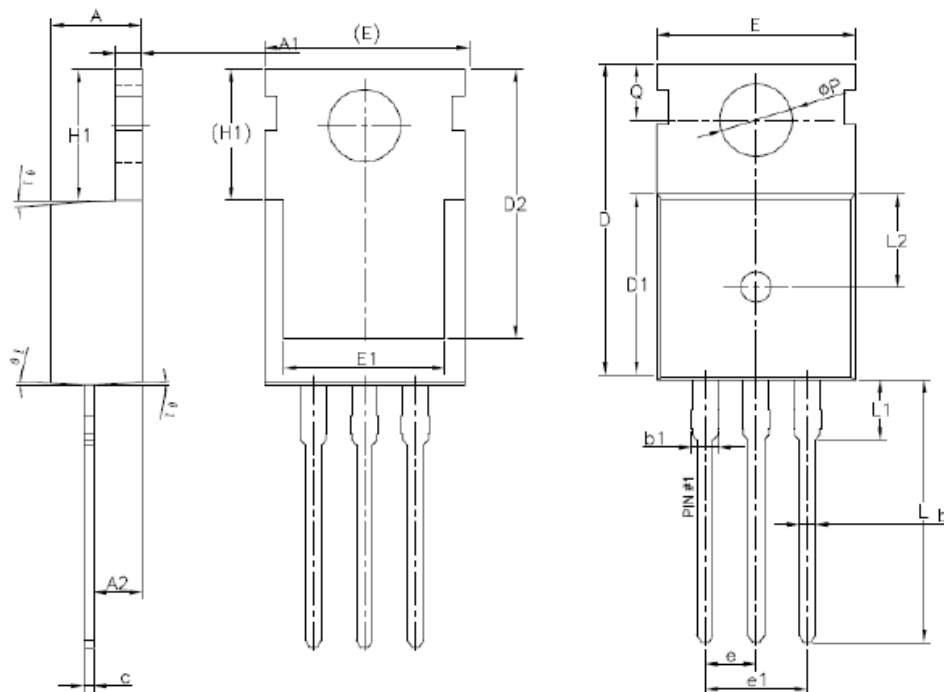

SYMBOL	MIN	NOM	MAX
A	4.40	4.50	4.60
A1	1.27	1.30	1.33
A2	2.30	2.40	2.50
b	0.70	—	0.90
b1	1.27	—	1.40
c	0.45	0.50	0.60
D	15.30	15.70	16.10
D1	9.10	9.20	9.30
D2	13.10	—	13.70
E	9.70	9.90	10.20
E1	7.80	8.00	8.20
e	2.49	2.54	2.59
e1	5.03	5.08	5.12
H1	6.30	6.50	6.70
L	12.78	13.08	13.38
L1	3.30	—	3.50
L2	4.50	4.60	4.70
ϕP	3.55	3.60	3.65
Q	2.73	—	2.87
$\theta 1$	1°	3°	5°

