

Flange Drawing (Size: mm)

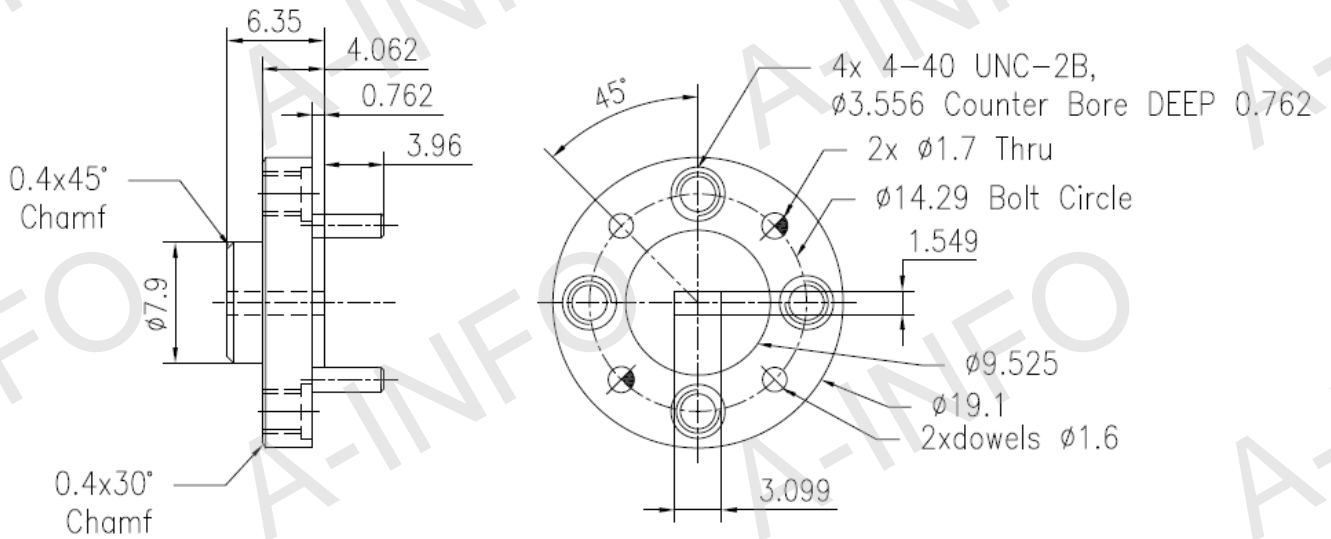

FUGP740
(equivalent to UG-387/U)

Test Results

Coupling (60.0-70.0GHz)

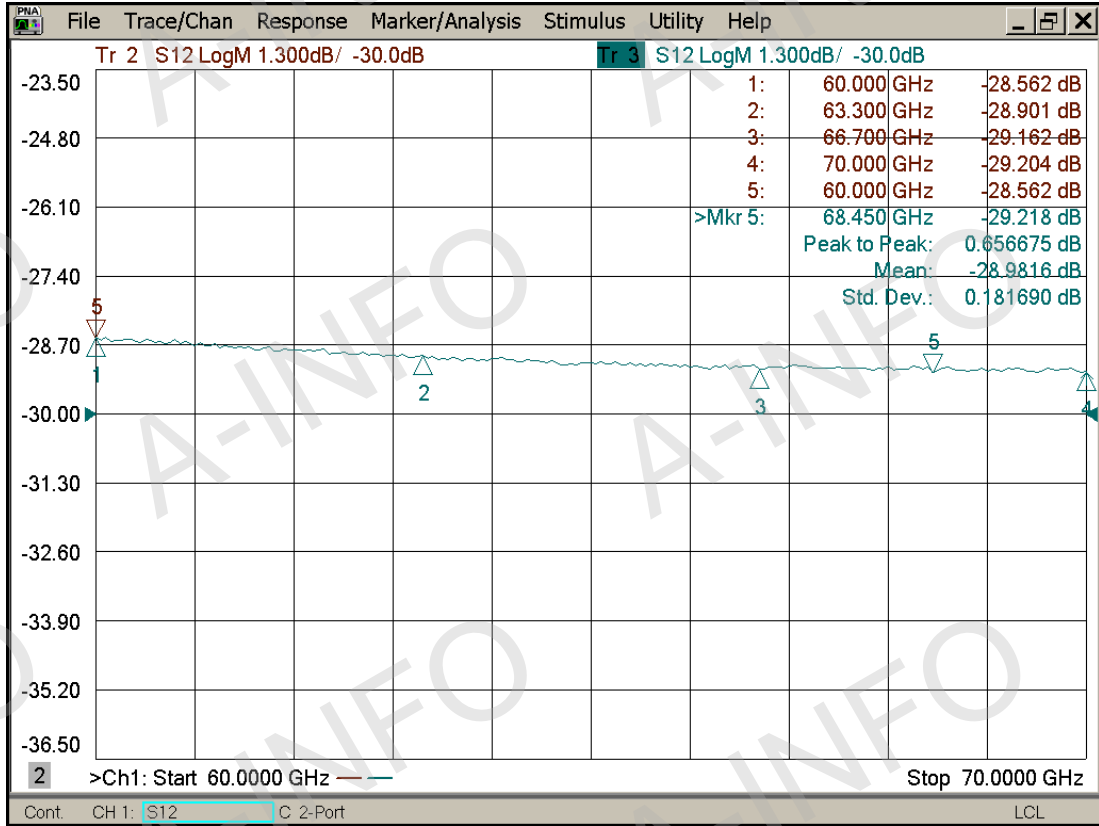

Coupling (70.0-90.0GHz)

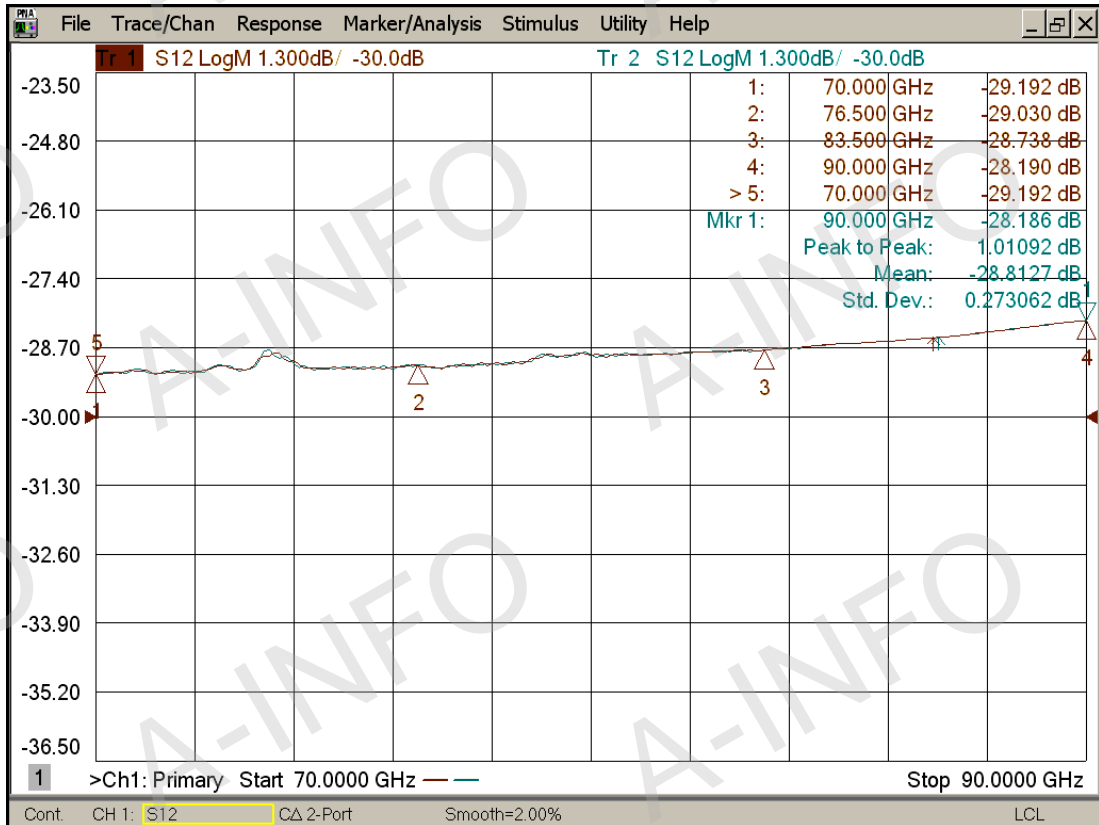

Directivity(60.0-70.0GHz)

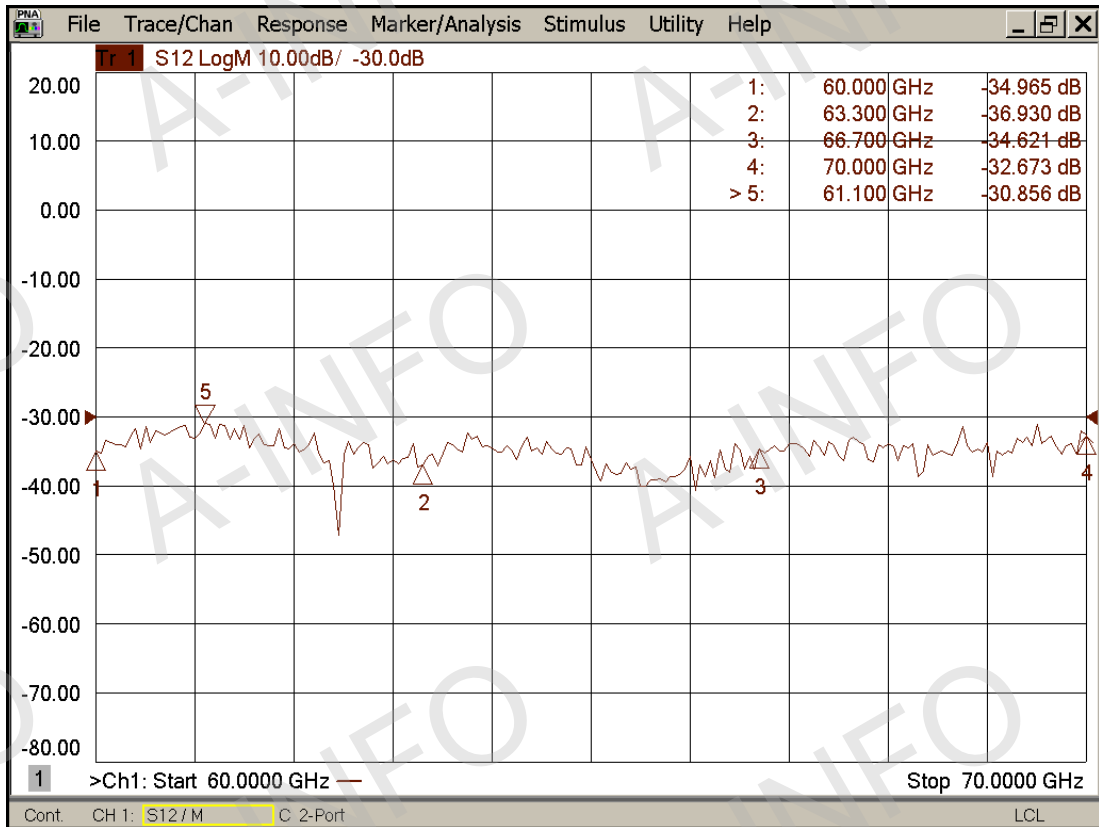

Directivity(70.0-90.0GHz)

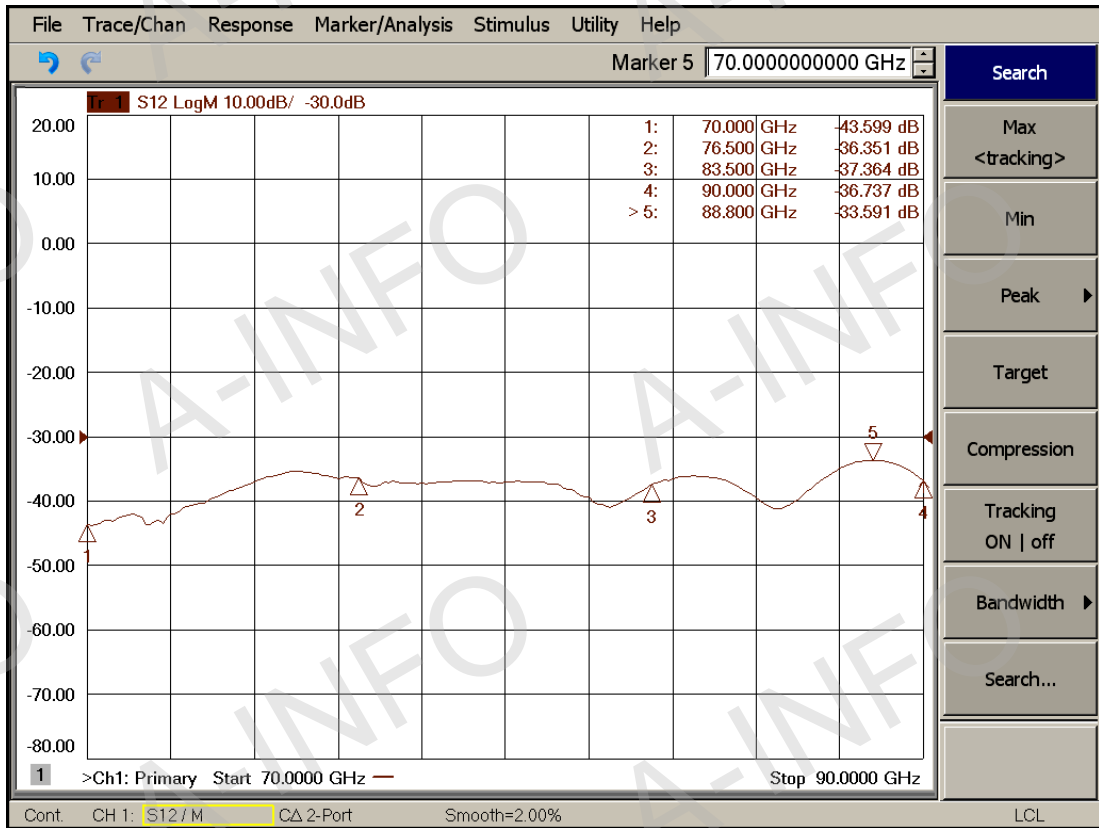

I.L. (60.0-70.0GHz) (Including the theoretical loss 4.35×10^{-3} dB)

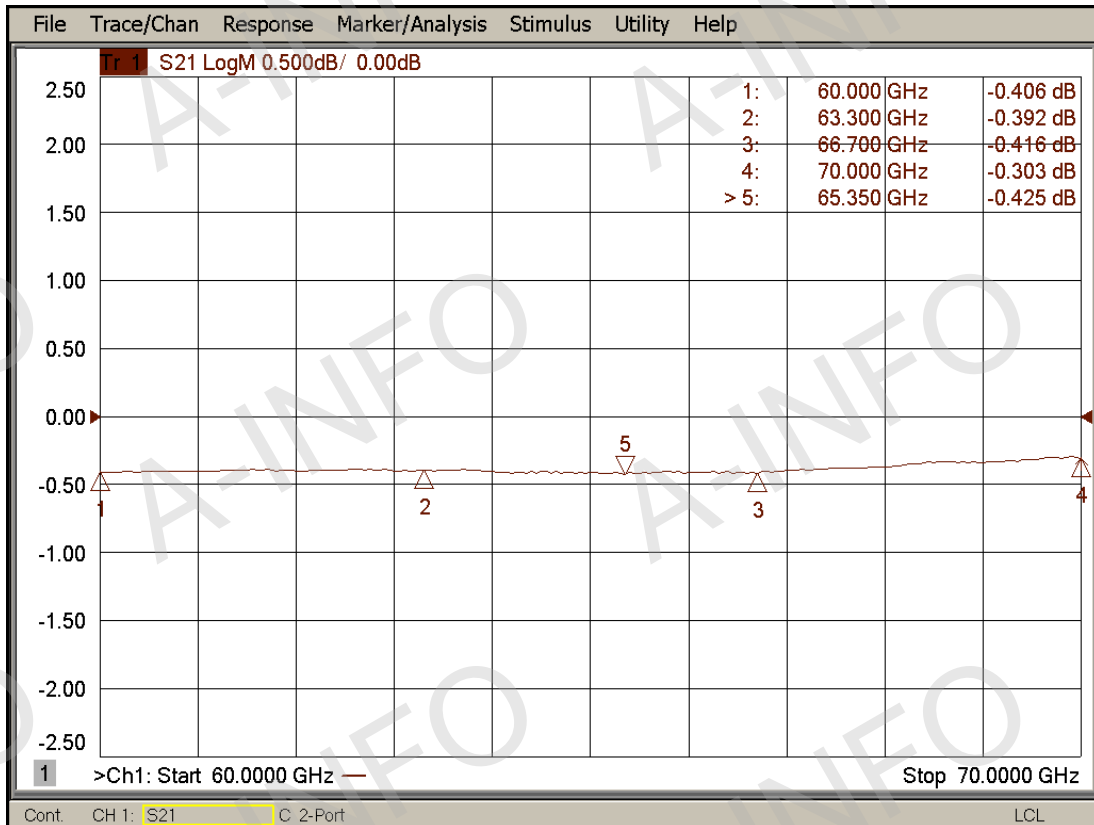

I.L. (70.0-90.0GHz) (Including the theoretical loss 4.35×10^{-3} dB)

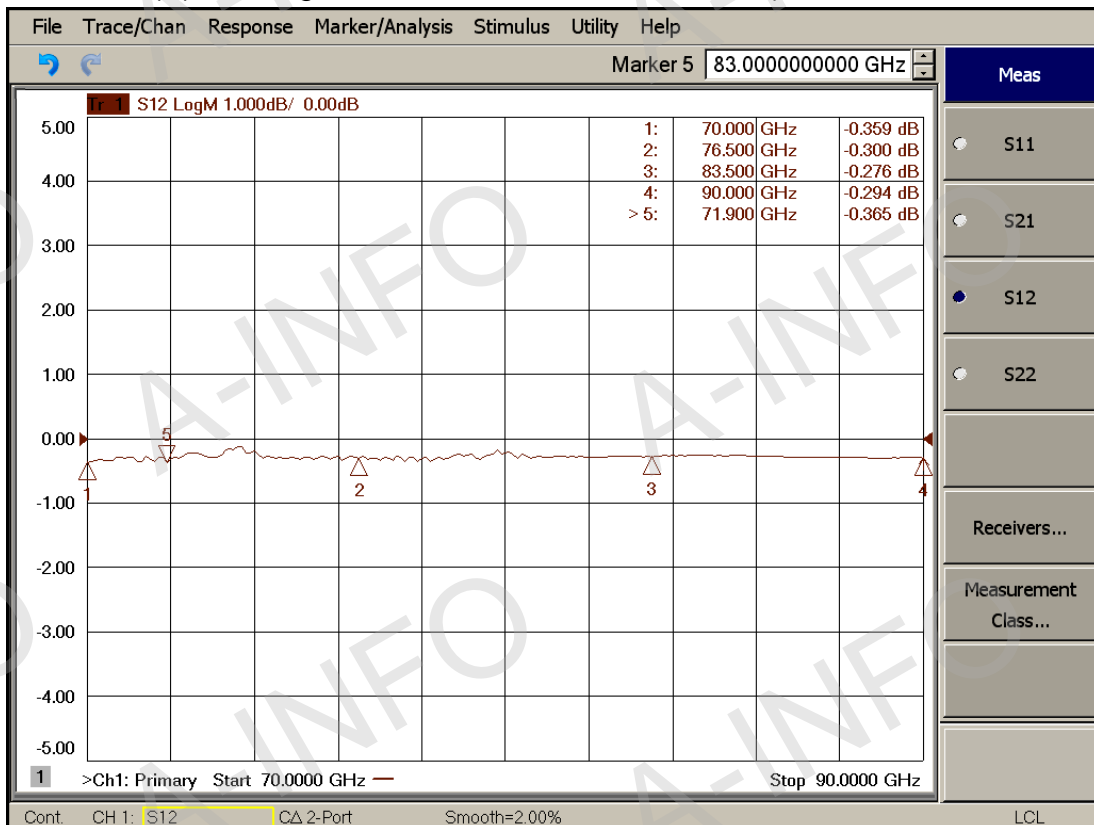

Mainline VSWR(60.0-70.0GHz)

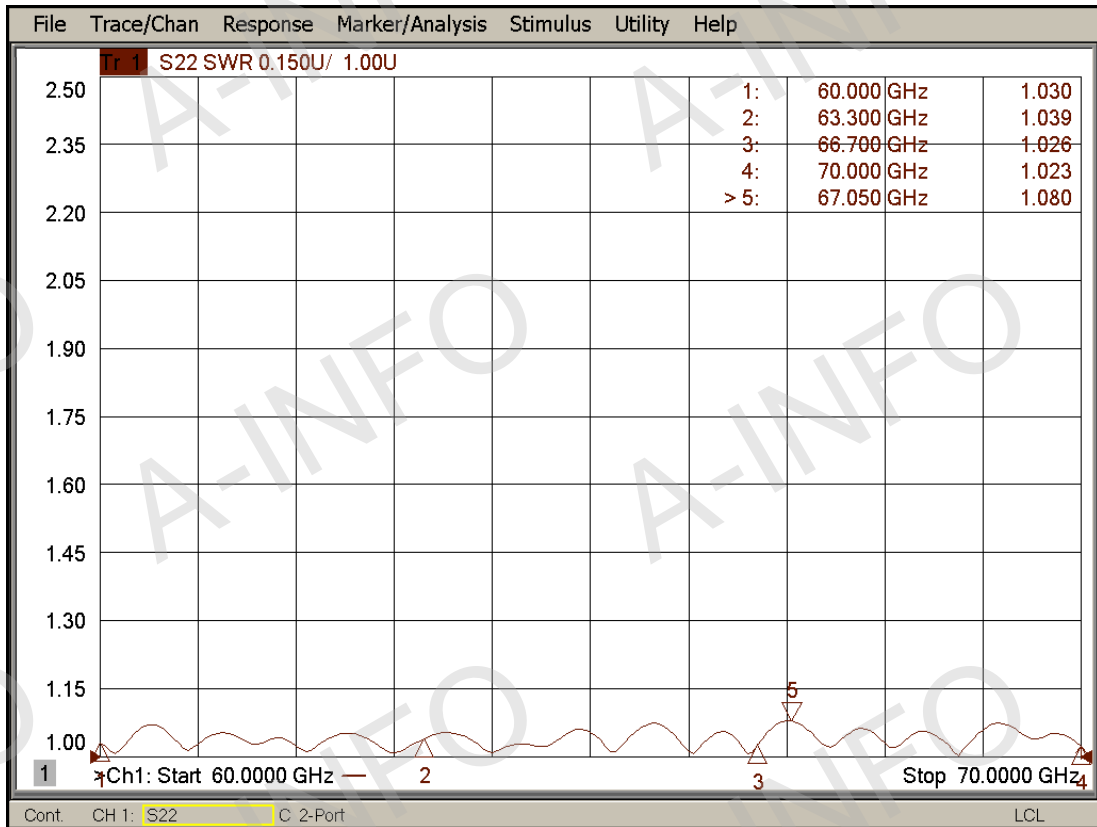

Mainline VSWR(70.0-90.0GHz)

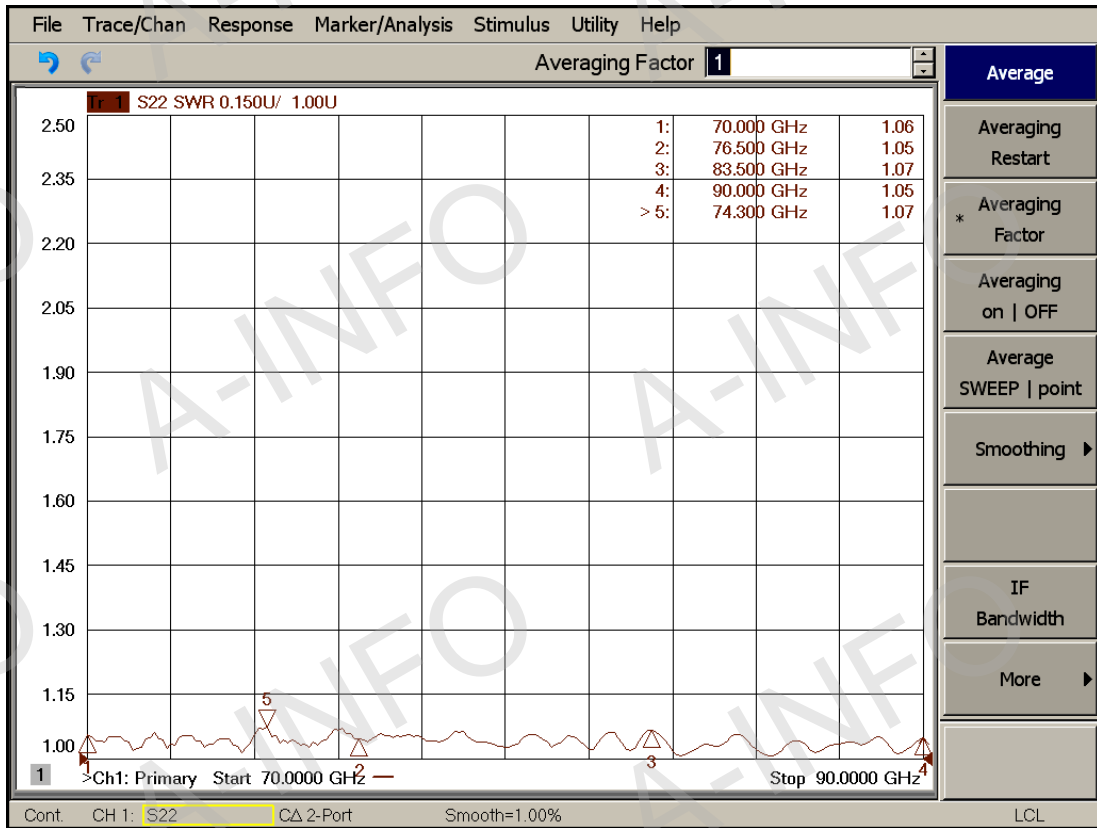

Secondline VSWR(60.0-70.0GHz)

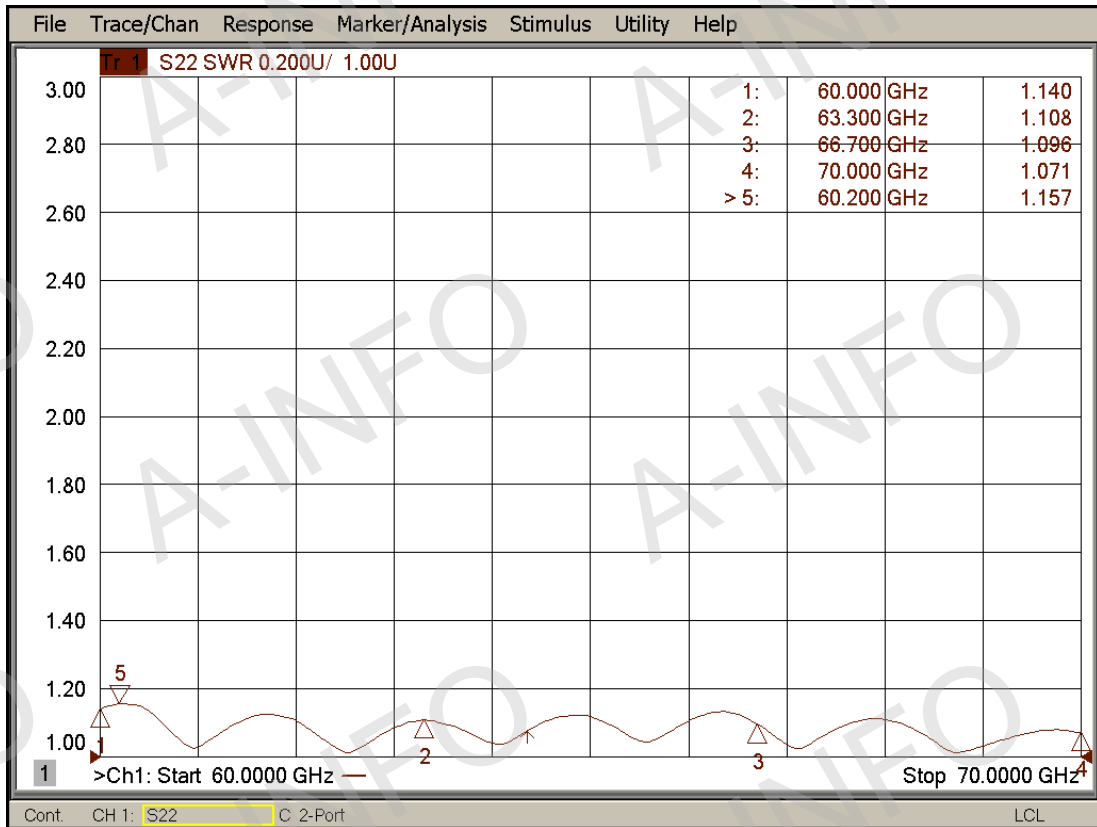

Secondline VSWR(70.0-90.0GHz)

