



TE0729 TRM

Revision: V.29

Exported on: 08/29/2018

1 Table of Contents

1	Table of Contents.....	2
2	Overview.....	4
2.1	Key Features.....	4
2.2	Block Diagram.....	5
2.3	Main Components.....	5
2.4	Initial Delivery State.....	6
3	Signals, Interfaces and Pins.....	7
3.1	Board to Board (B2B) I/Os.....	7
3.2	JTAG Interface.....	7
3.3	System Controller I/O Pins.....	7
3.4	On-board LEDs.....	8
3.5	Clocking.....	8
3.6	Default MIO mapping.....	8
3.7	Boot Modes.....	9
4	Processing System (PS) Peripherals.....	10
5	I2C Interface.....	11
5.1	I2C addresses for on-board components.....	11
6	On-board Peripherals.....	12
6.1	Gigabit Ethernet.....	12
6.2	USB Interface.....	13
6.3	RTC - Real Time Clock.....	13
6.4	MAC-Address EEPROMs.....	13
6.5	Watchdog.....	13
7	Power and Power-On Sequence.....	14
7.1	Power Supplies.....	14
7.2	Bank Voltages.....	14
7.3	Power-up sequence at start-up.....	14
8	Board to Board Connectors.....	16
9	Technical Specification.....	17
9.1	Absolute Maximum Ratings.....	17
9.2	Recommended Operating Conditions.....	17
9.3	Physical Dimensions.....	17
9.4	Operating Temperature Ranges.....	18
9.5	Weight.....	18

10	Revision History	19
10.1	Hardware Revision History	19
10.2	Document Change History	19
11	Disclaimer	20
11.1	Data privacy	20
11.2	Document Warranty	20
11.3	Limitation of Liability	20
11.4	Copyright Notice	20
11.5	Technology Licenses	20
11.6	Environmental Protection	20
11.7	REACH, RoHS and WEEE	20

2 Overview

The Trenz Electronic TE0729 is an industrial-grade SoM (System on Module) based on Xilinx Zynq-7000 SoC (XC7Z020). Refer to trenz.org/teb0729-info for online version of this manual and additional technical documentation of the product.

2.1 Key Features

- Industrial-grade Xilinx Zynq-7000 (XC7Z020) SoM
 - Dual-core ARM Cortex-A9 MPCore™ with CoreSight™
 - 136 x FPGA I/Os (58 LVDS pairs possible)
 - 8 x PS MIO pins
- 16-bit wide 512 MByte DDR3 SDRAM
- 32 MByte QSPI Flash memory
- 4 GByte eMMC Flash memory
- 1 x 10/100/1000 Mbps Ethernet transceiver PHY
- 2 x 10/100 Mbps Ethernet transceiver PHYs
- 3 x MAC address EEPROMs
- Hi-speed USB 2.0 ULPI transceiver with full OTG support
- Plug-on module with two 120-pin connectors
- Evenly spread supply pins for good signal integrity
- On-board high-efficiency DC-DC converters
 - 4.0 A x 1.0 V power rail
 - 1.5 A x 1.5 V power rail
 - 1.5 A x 1.8 V power rail
 - 1.5 A x 2.5 V power rail
- System management
- eFUSE bit-stream encryption
- AES bitstream encryption
- Temperature compensated RTC (real-time clock)
- User LED
- Rugged for shock and high vibration

Assembly options for cost or performance optimization available upon request.

2.2 Block Diagram

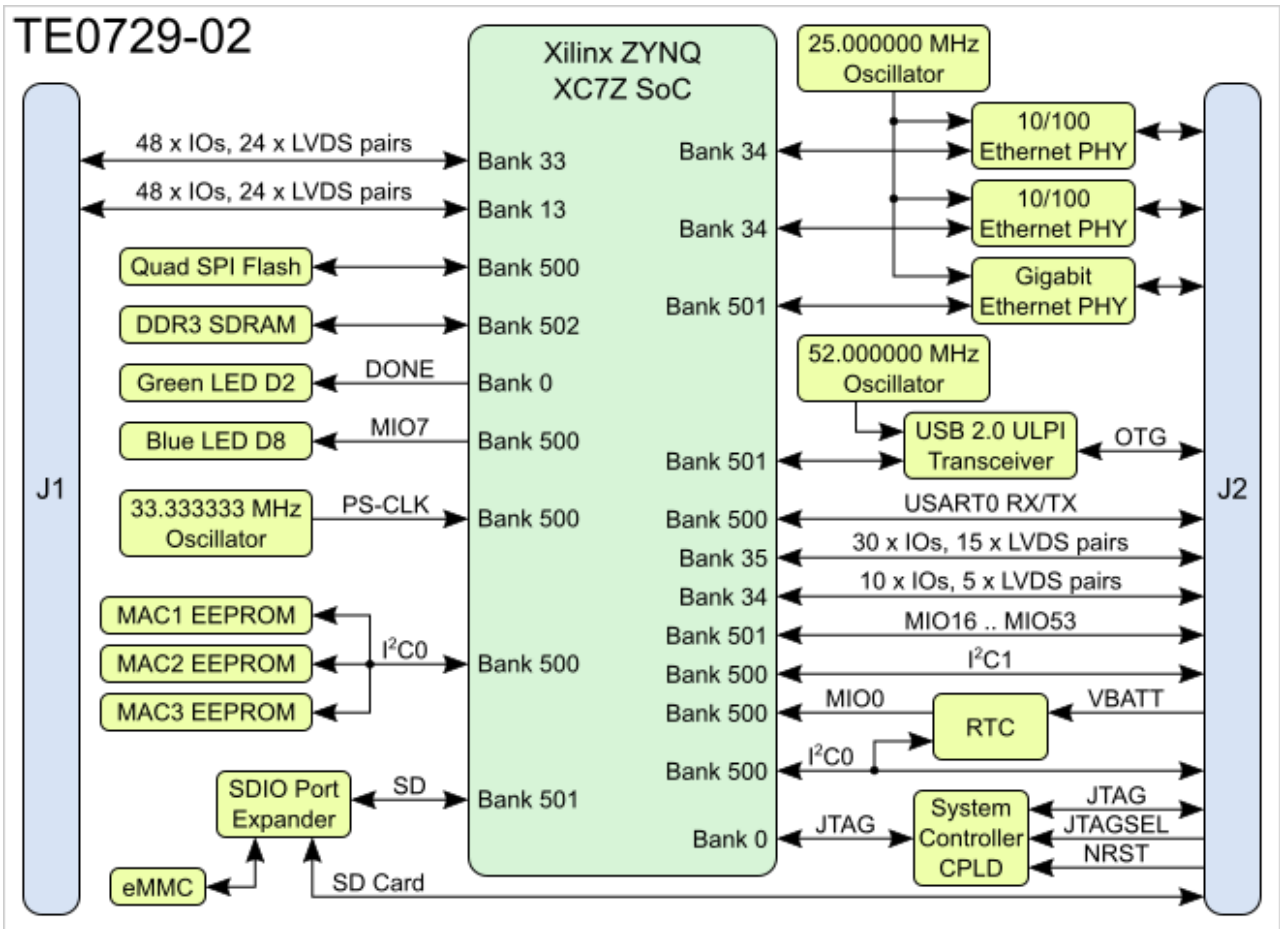

2.3 Main Components

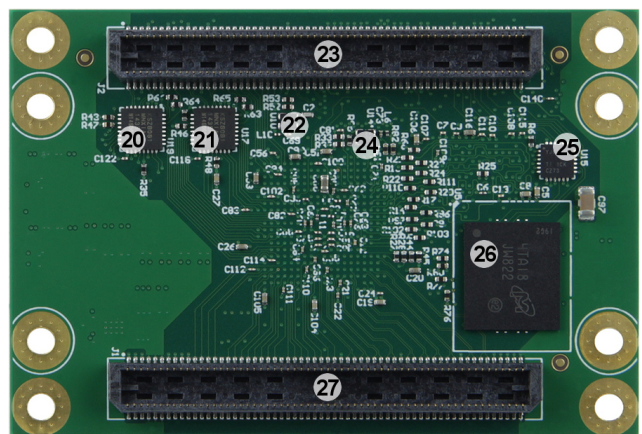
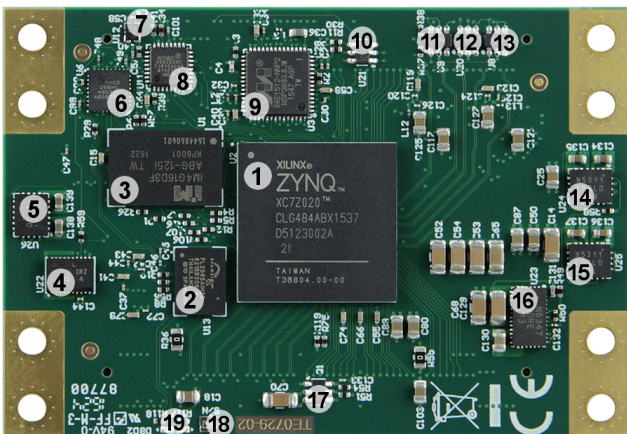

1. Xilinx Zynq-7000 all programmable SoC, U2
2. 32 MByte quad SPI Flash memory, U13
3. 4 Gbit DDR3/L SDRAM, U1
4. Low-power RTC with battery backed SRAM, U22
5. 1A PowerSoC DC-DC converter (1.5V), U26
6. System Controller CPLD, U6

7. Low-power programmable oscillator @ 52.000000 MHz (OTG-RCLK), U12
8. Hi-speed USB 2.0 ULPI transceiver, U11
9. Gigabit Ethernet (GbE) transceiver, U3
10. Ultra-low supply-current voltage monitor, U21
11. 2K I²C serial EEPROM with EUJ-48™ node identity, U9
12. 2K I²C serial EEPROM with EUJ-48™ node identity, U20
13. 2K I²C serial EEPROM with EUJ-48™ node identity, U8
14. 1A PowerSoC DC-DC converter (2.5V), U24
15. 1A PowerSoC DC-DC converter (1.8V), U25
16. 4A PowerSoC DC-DC converter (1.0V), U23
17. 3A PFET load switch with configurable slew rate (3.3V), Q1
18. Serial number (traceability) pad
19. Green LED D2 and red LED D8
20. 10Base-T/100Base-TX Ethernet PHY, U19
21. 10Base-T/100Base-TX Ethernet PHY, U17
22. Low-power programmable oscillator @ 25.000000 MHz (ETH_CLKIN), U10
23. 120-pin double-row REF-189019-02 B2B connector, J1
24. Low-power programmable oscillator @ 33.333333 MHz (PS-CLK), U14
25. SDIO port expander with voltage-level translation, U15
26. eMMC NAND Flash, U5
27. 120-pin double-row REF-189019-02 B2B connector, J2

2.4 Initial Delivery State

Storage device name	Content	Notes
24AA025E48 EEPROMs	User content programmed	notValid MAC address from manufacturer
eMMC Flash-Memory	Empty, not programmed	Except serial number programmed by flash vendor
SPI Flash OTP Area	Empty, not programmed	Except serial number programmed by flash vendor
SPI Flash Quad Enable bit	Programmed	
SPI Flash main array	Demo design	
eFUSE USER	Not programmed	
eFUSE Security	Not programmed	

3 Signals, Interfaces and Pins

3.1 Board to Board (B2B) I/Os

Bank	Type	B2B	IO count	IO Voltage	Notes
500	MIO	J2-872 J2-88		3,3 V	MIO0, MIO9
500	MIO	J2-934 J2-95 J2-94 J2-96		3,3 V	Configured as I2C1 and USART0 by default, Configurable as GPIO by user
13	HR	J1	48	User	
33	HR	J1	48	User	
35	HR	J2	30	3,3 V	
34	GPIO	J2	10	2,5 V	Configured as DISP_RX by default, Configurable as GPIO by user

For detailed information about the pin out, please refer to the [Master Pin-out table](#).

3.2 JTAG Interface

JTAG access to the Xilinx Zynq-7000 device is provided through B2B connector J2.

Signal	B2B Pin
TCK	J2-119
TDI	J2-115
TDO	J2-117
TMS	J2-113

 JTAGSEL pin 111 of B2B connector J2 should be kept low or grounded for normal operation.

3.3 System Controller I/O Pins

Special purpose pins used by TE0729:

Name	Note
NRST	Reset-Signal from Watchdog, available at B2B J2-89
NRST_IN	External Reset, available at B2B J2-91

For details see: TE0729 CPLD

3.4 On-board LEDs

There are 3 LED's on TE0729:

LED	Color	Connected to	Notes
D1	red	System Controller	Global Status LED
D2	green	DONE	Inverted DONE, ON when FPGA not configured
D8	red	MIO7	OFF when PS7 not booted and not controlling MIO7 by software, else user controlled

 LED D2 is connected to the FPGA Done pin and will go off as soon as PL is configured.

This LED will not operate if the System Controller can not power on the 3.3V output rail that also powers the 3.3V circuitry on the module.

3.5 Clocking

Clock	Frequency	IC	FPGA	Notes
PS-CLK	33.333333 MHz	U14	PS_CLK	PS subsystem main clock
ETH_CLKIN	25.000000 MHz	U10	-	Ethernet PHYs reference clock
	52.000000 MHz	U12	-	USB PHY reference clock

3.6 Default MIO mapping

MIO	Configured as	B2B	Notes
0	GPIO	J2-87	B2B
1	QSPIO	-	SPI Flash-CS
2	QSPIO	-	SPI Flash-DQ0
3	QSPIO	-	SPI Flash-DQ1
4	QSPIO	-	SPI Flash-DQ2
5	QSPIO	-	SPI Flash-DQ3
6	QSPIO	-	SPI Flash-SCK
7	GPIO	-	Red LED D8
8	-	-	QSPIO feedback clock
9	GPIO	J2-88	B2B
10	I2C0 SDA	J2-90	B2B
11	I2C0 SCL	J2-92	B2B
12	I2C1 SDA	J2-93	B2B (SDA on-board I2C, also configurable as GPIO by user)
13	I2C1 SCL	J2-95	B2B (SCL on-board I2C, also configurable as GPIO by user)
14	USART0 RX	J2-94	B2B (RX on-board UART, also configurable as GPIO by user)
15	USART0 TX	J2-96	B2B (TX on-board UART, also configurable as GPIO by user)
16..27	ETH0		Ethernet RGMII PHY

MIO	Configured as	B2B	Notes
28..39	USB0		USB ULPI PHY
40	SDIO0	J2-100	
41	SDIO0	J2-102	
42	SDIO0	J2-104	
43	SDIO0	J2-106	
44	SDIO0	J2-108	
45	SDIO0	J2-110	
46	GPIO	-	RTC Interrupt
47	-	-	-
48	GPIO	SEL_SD	SD Card multiplexer control
49	GPIO	-	USB Reset
50	GPIO	-	ETH0 Interrupt
51	GPIO	-	ETH0 Reset
52	ETH0	-	MDC
53	ETH0	-	MDIO

3.7 Boot Modes

TE0729 supports primary boot from

- JTAG
- SPI Flash
- SD Card

Boot from on-board eMMC is also supported as secondary boot (FSBL must be loaded from SPI Flash).

The boot modes are controlled by the Pins 'BOOT1' and 'BOOT2' on the board to board (B2B) connector. Pins routed through the CPLD by default firmware with pull-up, if not connected on B2B.

BOOTMODE2 (M3)	BOOTMODE1 (M2)	M1	M0	Boot mode
LOW	LOW	LOW	LOW	JTAG
LOW	HIGH	LOW	LOW	Invalid
HIGH	LOW	LOW	LOW	SPI (eMMC as secondary boot possible)
HIGH	HIGH	LOW	LOW	SD Card

4 Processing System (PS) Peripherals

Peripheral	IC	Designat or	PS	MIO	Notes
EEPROM I2C	24AA025E48T-I/ OT	U8	I2C0	MIO10, MIO11	MAC Address
EEPROM I2C	24AA025E48T-I/ OT	U9	I2C0	MIO10, MIO11	MAC Address
EEPROM I2C	24AA025E48T-I/ OT	U20	I2C0	MIO10, MIO11	MAC Address
RTC	ISL12020MIRZ	U22	I2C0	MIO10, MIO11	Temperature compensated real time clock
RTC Interrupt	ISL12020MIRZ	U22	GPI O	MIO46	Real Time Clock Interrupt
SPI Flash	S25FL256SAGBH I20	U13	QSPI 0	MIO1..MIO6	
Ethernet0 10/100/1000 Mbps PHY	88E1512-A0- NNP2I000	U3	ETH 0	MIO16...MI O27	
Ethernet0 10/100/1000 Mbps PHY Reset			GPI O	MIO51	
Ethernet1 10/100 Mbps PHY	KSZ8081MLXCA	U17	-	(EMIO)	
Ethernet1 10/100 Mbps PHY Reset			-	(EMIO)	
Ethernet2 10/100 Mbps PHY	KSZ8081MLXCA	U19	-	(EMIO)	
Ethernet2 10/100 Mbps PHY Reset			-	(EMIO)	
USB	USB3320C-EZK	U11	USB 0	MIO28...MI O39	
USB Reset			GPI O	MIO49	
eMMC (embedded eMMC)	MTFC4GMVEA-4 M IT	U5	SDI O0	MIO40...MI O45	

5 I2C Interface

The on-board I2C components are connected to MIO10 and MIO11 and configured as I2C0 by default.

5.1 I2C addresses for on-board components

Device	I2C-Address	Notes
EEPROM for MAC1	0x50	
EEPROM for MAC2	0x51	
EEPROM for MAC3	0x52	
RTC	0x6F	
Battery backed RAM	0x57	Integrated in RTC

6 On-board Peripherals

6.1 Gigabit Ethernet

The TE0729 is equipped with a Marvell Alaska 88E1512 Gigabit Ethernet PHY (U3) connected to PS Ethernet GEM0 (referenced in this manual Ethernet0). The I/O Voltage is fixed at 1.8V. The reference clock input of the PHY is supplied from an on board 25MHz oscillator (U10).

Ethernet0 PHY connection:

PHY PIN	ZYNQ PS	Notes
MDC/MDIO	MIO52, MIO53	-
LED0	-	pin J2-57 on B2B connector
LED1	-	pin J2-59 on B2B connector
LED2/Interrupt	MIO46	-
CONFIG	-	Connected to GND, PHY Address 0
RESETn	MIO51	-
RGMII	MIO16..MIO27	-
SGMII	-	B2B J2
MDI	-	B2B J2

The TE0729 SoM is also equipped with two additional Microchip KSZ8081MLXCA Ethernet PHY's (IC's U17 and U19) to provide further 10/100 Mbps Ethernet interfaces with the identifiers Ethernet1 and Ethernet2. The reference clock input of both PHYs is supplied from the same 25MHz oscillator (U10), which also provides Ethernet0 Gigabit PHY with a reference clock signal.

Ethernet1 PHY connection to B2B-connectors:

PHY PIN	B2B	Notes
ETH1_RX_P	J2-26	-
ETH1_RX_N	J2-28	-
ETH1_TX_P	J2-20	-
ETH1_TX_N	J2-22	-
ETH1_LED0	J2-34	Status LED
ETH1_LED1	J2-32	Transmission LED

Ethernet2 PHY connection to B2B-connectors:

PHY PIN	B2B	Notes
ETH2_RX_P	J2-2	-
ETH2_RX_N	J2-4	-
ETH2_TX_P	J2-8	-
ETH2_TX_N	J2-10	-
ETH2_LED0	J2-16	Status LED
ETH2_LED1	J2-14	Transmission LED

All other pins of the PHYs are connected to Bank34 of Zynq, see schematic for further details.

6.2 USB Interface

Microchip USB3320 is connected via ULPI interface to the Zynq PS USB0. I/O voltage level is fixed at 1.8V and PHY reference clock input is supplied from the on-board 52.000000 MHz oscillator (U12).

PHY connection:

PHY Pin	Zynq Pin	B2B Name	Notes
ULPI	MIO28..39-		Zynq USB0 MIO pins are connected to the PHY
REFCLK	-	-	52MHz from on board oscillator (U12)
REFSEL[0..2]	-	-	All three connected to the GND, selects 52.000000 MHz as reference clock
RESETB	MIO49	-	Active-low reset
CLKOUT	MIO36	-	Connected to 1.8V, selects reference clock operation mode
DP,DM	-	OTG_D_P, OTG_D_N	USB data lines
CPEN	-	VBUS_V_EN	External USB power switch active-high enable signal
VBUS	-	USB_VBUS	Connected to the USB-VBUS via resistor. Check reference schematic
ID	-	OTG_ID	For an A-Device connected to the ground, for a B-Device left floating

The schematic for the USB connector and required components is different depending on the USB usage. USB standard A or B connectors can be used for Host or Device modes. A Mini USB connector can be used for USB Device mode. A USB Micro connector can be used for Device mode, OTG Mode or Host Mode.

6.3 RTC - Real Time Clock

An Intersil temperature compensated real time clock IC ISL12020MIRZ is used for timekeeping (U22). Battery voltage must be supplied to the module from the main board.

Battery backed registers are accessed at I2C slave address 0x57. General purpose RAM is accessed at I2C slave address 0x6F. This RTC IC is supported by the Linux OS, so it can be used as hwclock device.

6.4 MAC-Address EEPROMs

TE0729 module has three Microchip 24AA025E48 EEPROMs (U8, U9 and U20) which contain globally unique EUI-48™ compatible 48-bit node (MAC) addresses. These EEPROMs are organized as two blocks of 128 x 8-bit memory. One of the blocks stores the 48-bit node address and is write protected, the other block is available for application use. EEPROMs are accessible using I²C slave address 0x50 for MAC-Address1 (U8), 0x51 for MAC-Address2 (U9), 0x52 for MAC-Address3 (U20).

6.5 Watchdog

TE0729 has support for hardware watchdog function. By default the watchdog is disabled at power up. Please contact Trenz Electronic for details how to enable watchdog function.

7 Power and Power-On Sequence

For startup, a power supply with minimum current capability of 3A is recommended.

VIN and 3.3VIN can be connected to the same source (3.3 V).

7.1 Power Supplies

Supply Voltage	Voltage Range	Notes
VIN	3.3 V to 5.5 V	
VIN 3.3V	3.3 V	

7.2 Bank Voltages

Bank	Voltage	Max. Value	Notes
501	1,8 V	-	ETH0 / USB0 / SDIO0
500	3,3 V	-	SPI / I2C / UART
502	1,5 V	-	DDR3-RAM
13	user	3,3 V	connected to 3,3V by default by 0-Ohm-Resistor R36
33	user	3,3 V	connected to 3,3V by default by 0-Ohm-Resistor R55
34	2,5 V	-	ETH / DISP
35	3,3 V	-	GPIO

7.3 Power-up sequence at start-up

The Trenz TE0729 is equipped with several DC-DC-voltage-regulators to generate the required on-board voltages with the values 1V (FPGA core), 1.8 V (VCC0 MIO, VCCAUX, AVCC, VCCPLL, VDD USB and ETH PHYs), 1.5V (DDR3), 2.5V (Industrial fast ETH-PHYs) and 3.3V (VCCIO, peripheral components).

In the first step at device start-up the voltages 1V and 1.8V are generated for the FPGA core and programmable logic banks. The voltages 1.5V and 2.5 V are enabled after the voltage 1V has stabilized. The voltage 3.3V is enabled by the CPLD system controller at last.

The voltage 3.3V is available on B2B-connector at pins J1-65, J1-66 and an indicator for stabilized on-board voltages in steady state.

 To avoid any damage to the SoM, check the 3.3V voltage before powering up the SoC's I/O bank voltages VCCIO_13 and VCCIO_33.

Pay attention to the voltage level of the I/O-signals, which must not be higher than VCCIO + 0.4V.

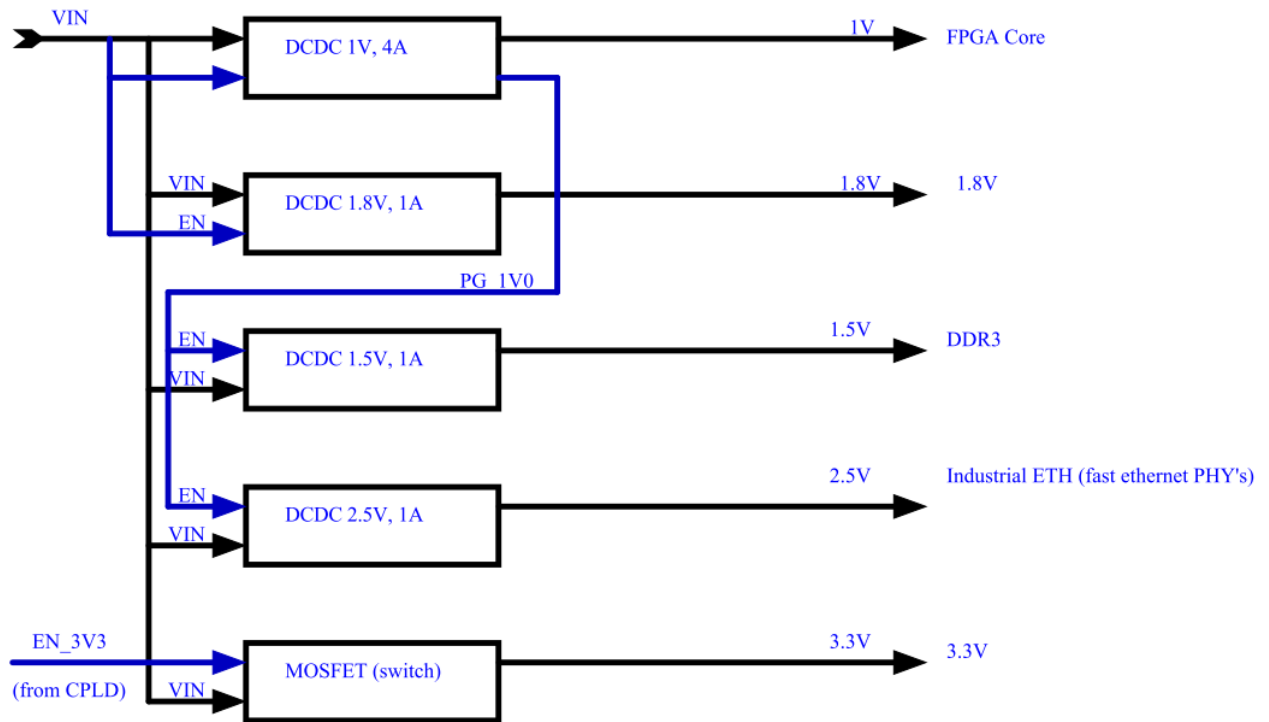

8 Board to Board Connectors

The TE0729 module has two 120-pin double-row REF-189019-02 connectors on the bottom side which are compatible with Samtec BSE-060-01-L-D-A connectors. Mating connectors on the baseboard are REF-189019-01, which are compatible with Samtec BTE-060-01-L-D-A connectors.

Order number	REF Number	Samtec Number	Type	Mated Height	Data sheet	Comment
-	REF-189019-02	BTE-060-01-L-D-A-K-TR	Module connector	5 mm	http://suddendocs.samtec.com/catalog_english/bte.pdf	Standard connector used on module
26663	REF-189019-01	BSE-060-01-L-D-A-TR	Baseboard connector	5 mm	http://suddendocs.samtec.com/catalog_english/bse.pdf	Standard connector used on board

Connector Specifications	Value
Insulator material	Liquid crystal polymer
Stacking height	5 mm
Contact material	Phosphor-bronze
Plating	Au or Sn over 50 μ " (1.27 μ m) Ni
Current rating	2 A per pin (1 pin powered per row)
Operating temperature range	-55 °C to +125 °C
Voltage rating	225 VAC with 5 mm stack height
Max cycles	100
RoHS compliant	Yes

9 Technical Specification

9.1 Absolute Maximum Ratings

Parameter	Min	Max	Units	Notes
VIN supply voltage	-0.1	3.75	V	
VBAT supply voltage	-0.3	6.0	V	
PL I/O bank supply voltage for HR I/O banks (VCCO)	-0.5	3.6	V	
I/O input voltage for HR I/O banks	-0.55	VCCO_X+0.55	V	
Voltage on module JTAG pins	-0.4	VCCO_0+0.55V	V	VCCO_0 is 3.3V nominal
Storage temperature	-40	+85	C	
Storage temperature without the ISL12020MIRZ	-55	+100	C	

 Assembly variants for higher storage temperature range on request

 Please check Xilinx Datasheet for complete list of Absolute maximum and recommended operating ratings for the Zynq device (DS181 Artix or DS182 Kintex).

9.2 Recommended Operating Conditions

Parameter	Min	Max	Units	Notes	Reference document
VIN supply voltage	2.5	3.6	V		
VBAT supply voltage	1.8	5.5	V		
PL I/O bank supply voltage for HR I/O banks (VCCO)	1.14	3.465	V		Xilinx document DS191
I/O input voltage for HR I/O banks	(*)	(*)	V	(*) Check datasheet	Xilinx document DS191 and DS187
Voltage on module JTAG pins	3.13 5	3.465	V	VCCO_0 is 3.3 V nominal	

9.3 Physical Dimensions

Please download the assembly diagram for exact values.

- Module size: 76 mm × 52 mm.
- Mating height with standard connectors: 4,25 mm.
- PCB thickness: 2 mm.

All dimensions are shown in millimeters.

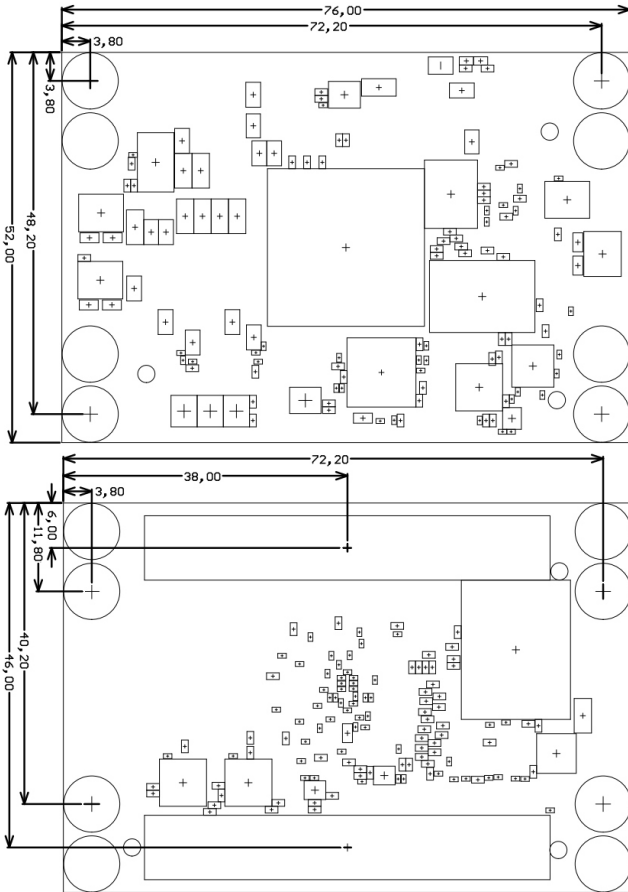

9.4 Operating Temperature Ranges

Commercial grade modules

All parts are at least commercial temperature range of 0°C to +70°C.

Industrial grade modules

All parts are at least industrial temperature range of -40°C to +85°C.

The module operating temperature range depends on customer design and cooling solution. Please contact us for options.

9.5 Weight

Weight	Part
21,6 g	Plain module

10 Revision History

10.1 Hardware Revision History

Date	Revision	Changes
2016-05-02	02	First production release
-	01	Prototypes

Hardware revision number is written on the PCB board together with the module model number separated by the dash.

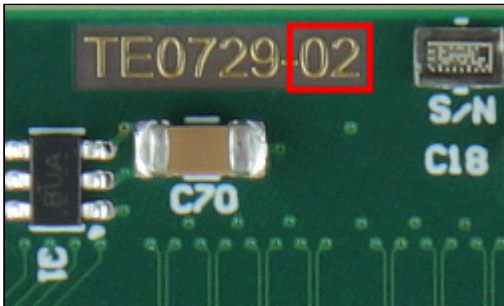

10.2 Document Change History

Date	Revision	Contributors	Description
 2018-08-29	v.29 V.29	John Hartfiel	<ul style="list-style-type: none"> • update Links
2017-11-06	v.28	Ali Naseri	<ul style="list-style-type: none"> • Updated B2B connector section.
2017-06-18	v.22	Jan Kumann	<ul style="list-style-type: none"> • New product images.
2017-06-07	v.21	Jan Kumann	<ul style="list-style-type: none"> • Minor re-formatting.
2017-05-22	v.12	Jan Kumann	<ul style="list-style-type: none"> • Sections rearranged for common style. • New physical dimension images. • Hardware revision image added. • New block diagram.
2017-03-24	v.11	John Hartfiel	<ul style="list-style-type: none"> • Correction: Boot Mode settings.
2016-06-14	v.10	Ali Naseri	<ul style="list-style-type: none"> • Initial release.

11 Disclaimer

11.1 Data privacy

Please also note our data protection declaration at <https://www.trenz-electronic.de/en/Data-protection-Privacy>

11.2 Document Warranty

The material contained in this document is provided “as is” and is subject to being changed at any time without notice. Trenz Electronic does not warrant the accuracy and completeness of the materials in this document. Further, to the maximum extent permitted by applicable law, Trenz Electronic disclaims all warranties, either express or implied, with regard to this document and any information contained herein, including but not limited to the implied warranties of merchantability, fitness for a particular purpose or non infringement of intellectual property. Trenz Electronic shall not be liable for errors or for incidental or consequential damages in connection with the furnishing, use, or performance of this document or of any information contained herein.

11.3 Limitation of Liability

In no event will Trenz Electronic, its suppliers, or other third parties mentioned in this document be liable for any damages whatsoever (including, without limitation, those resulting from lost profits, lost data or business interruption) arising out of the use, inability to use, or the results of use of this document, any documents linked to this document, or the materials or information contained at any or all such documents. If your use of the materials or information from this document results in the need for servicing, repair or correction of equipment or data, you assume all costs thereof.

11.4 Copyright Notice

No part of this manual may be reproduced in any form or by any means (including electronic storage and retrieval or translation into a foreign language) without prior agreement and written consent from Trenz Electronic.

11.5 Technology Licenses

The hardware / firmware / software described in this document are furnished under a license and may be used / modified / copied only in accordance with the terms of such license.

11.6 Environmental Protection

To confront directly with the responsibility toward the environment, the global community and eventually also oneself. Such a resolution should be integral part not only of everybody's life. Also enterprises shall be conscious of their social responsibility and contribute to the preservation of our common living space. That is why Trenz Electronic invests in the protection of our Environment.

11.7 REACH, RoHS and WEEE

REACH

Trenz Electronic is a manufacturer and a distributor of electronic products. It is therefore a so called downstream user in the sense of **REACH**. The products we supply to you are solely non-chemical products (goods). Moreover and under normal and reasonably foreseeable circumstances of application, the goods supplied to you shall not release

any substance. For that, Trenz Electronic is obliged to neither register nor to provide safety data sheet. According to present knowledge and to best of our knowledge, no [SVHC \(Substances of Very High Concern\) on the Candidate List](#) are contained in our products. Furthermore, we will immediately and unsolicited inform our customers in compliance with REACH - Article 33 if any substance present in our goods (above a concentration of 0,1 % weight by weight) will be classified as SVHC by the [European Chemicals Agency \(ECHA\)](#).

RoHS

Trenz Electronic GmbH herewith declares that all its products are developed, manufactured and distributed RoHS compliant.

WEEE

Information for users within the European Union in accordance with Directive 2002/96/EC of the European Parliament and of the Council of 27 January 2003 on waste electrical and electronic equipment (WEEE).

Users of electrical and electronic equipment in private households are required not to dispose of waste electrical and electronic equipment as unsorted municipal waste and to collect such waste electrical and electronic equipment separately. By the 13 August 2005, Member States shall have ensured that systems are set up allowing final holders and distributors to return waste electrical and electronic equipment at least free of charge. Member States shall ensure the availability and accessibility of the necessary collection facilities. Separate collection is the precondition to ensure specific treatment and recycling of waste electrical and electronic equipment and is necessary to achieve the chosen level of protection of human health and the environment in the European Union. Consumers have to actively contribute to the success of such collection and the return of waste electrical and electronic equipment. Presence of hazardous substances in electrical and electronic equipment results in potential effects on the environment and human health. The symbol consisting of the crossed-out wheeled bin indicates separate collection for waste electrical and electronic equipment.

Trenz Electronic is registered under WEEE-Reg.-Nr. DE97922676.

Mouser Electronics

Authorized Distributor

Click to View Pricing, Inventory, Delivery & Lifecycle Information:

[Trenz Electronic:](#)

[TE0729-02-2IF-K](#) [TE0729-02-02IF-S](#) [TE0729-02-2IF](#)