

Technical Specification

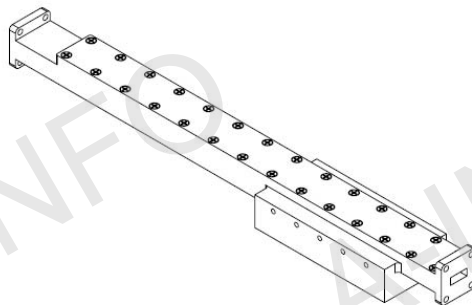

EIA WR	WR42
Frequency Range(GHz)	18.0-26.5
Attenuation(dB)	20
Attenuation Accuracy(dB)	±1.0 Max.
Attenuation Sensitivity(dB)	±0.9 Max.
VSWR	1.2:1 Max.
Average Power(W)	100 CW
Peak Power(KW)	120
Flange	FBP220(UBR220)
Material	Al
Size(mm)	279.4 x 40 x 29.6
Net Weight(Kg)	0.3 Around

Outline Drawing (Size: mm)

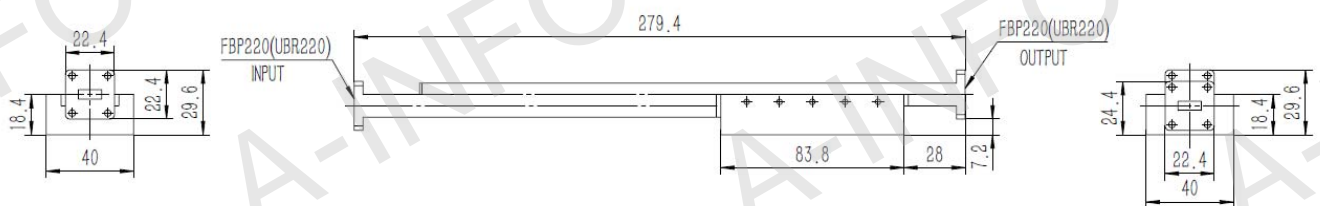

Flange Drawing (Size: mm)

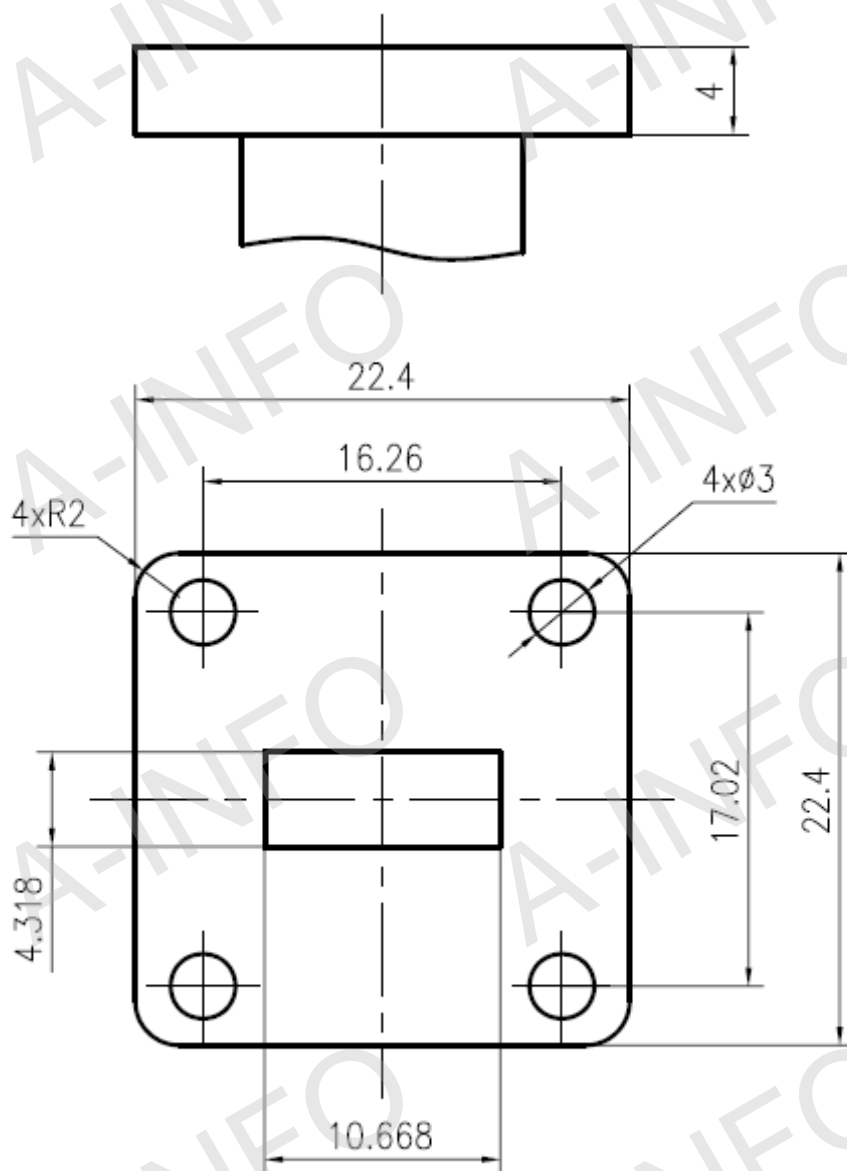

FBP220

Test Result

Attenuation & VSWR

