

Technical Specification

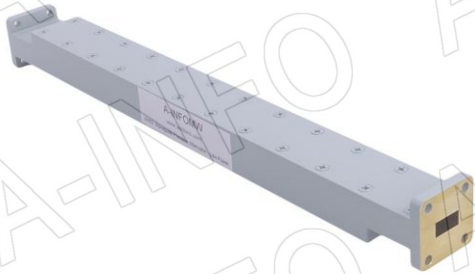

EIA WR	WR51
Frequency Range(GHz)	15.0 – 22.0
Attenuation(dB)	50
Attenuation Accuracy(dB)	±0.9 Max.
Attenuation Sensitivity(dB)	±0.7 Max.
VSWR	1.10:1 Max.
Average Power(W CW)	1
Peak Power(KW)	1
Flange	FBP180(UBR180)
Material	Cu
Size(mm)	304.8 x 30.2 x 37.6
Net Weight(Kg)	1.14 Around

Outline Drawing (Size: mm)

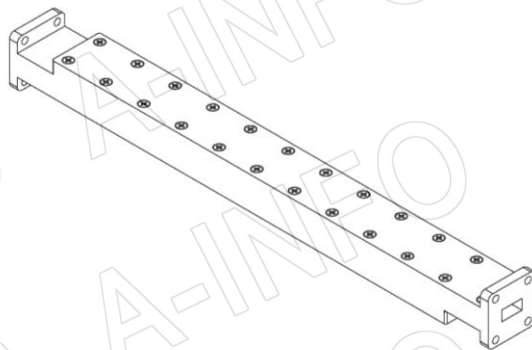

Flange Drawing (Size: mm)

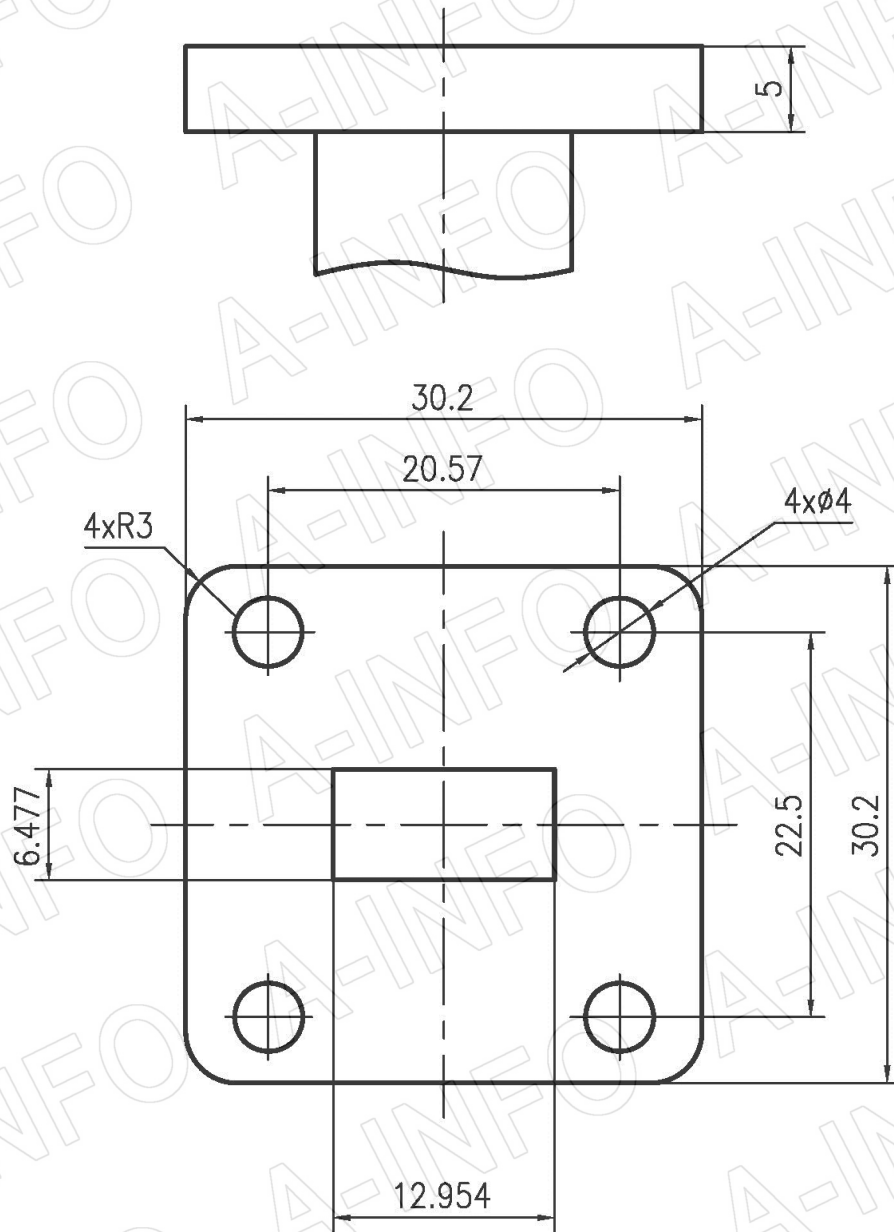

FBP180

AINFO Inc.

Page 2 of 3

China(Beijing): Tel: (+86) 10-6266-7326,
China(Chengdu): Tel: (+86) 28-8519-2786,
USA: Tel: (+1) 949-639-9688,

(+86) 10-6266-7327 Fax: (+86) 10-6266-7379
(+86) 28-8519-3044 Fax: (+86) 28-8519-3068
(+1) 949-639-9608 Fax: (+1) 949-639-9670

Website: www.ainfoinc.com
Email: sales@ainfoinc.com

Test Result

Attenuation & VSWR

CH1	\$11	SWR	100 m / REF 1	5: 1.0226	15.000 000 000 GHz
CH2	\$21	LOG	.3 dB / REF -50 dB	5: -49.645 dB	15.035 000 000 GHz
CH3	\$21	LOG	.3 dB / REF -50 dB	5: -50.355 dB	17.240 000 000 GHz
CH4	\$22	SWR	100 m / REF 1	5: 1.0338	15.000 000 000 GHz

