

2J6924B

CELLULAR/LTE Screw Mount

Key Features

CELLULAR / LTE

- 698-960 MHz
- 1710-2170 MHz
- 2500-2700 MHz

Screw Mount

Low Profile

Anti-Rotation Mechanism

Ground Plane Independent

Customizable Cable and Connector

Dimensions 80 × 74 × 25.6 mm

Certificates: IP67, IP69



1. Antenna and electrical specifications

Cable 1

Parameters	CELLULAR / LTE Antenna		
Standards	2G,3G and 4G		
Band (MHz)	700/850/900	1700/1800/1900/2100	2600
Frequency (MHz)	698-960	1710-2170	2500-2700
Return Loss (dB)	~-13.6	~-12.7	~-14.4
VSWR	~1.9:1	~2.2:1	~1.3:1
Efficiency (%)	~52.3	~45.0	~46.3
Peak Gain (dBi)	~3.1	~3.5	~3.4
Average Gain (dB)	~-2.8	~-3.3	~-3.3
Impedance (Ohm)	50		
Polarisation	Linear		
Radiation Pattern	Omni-Directional		
Max. Input Power (W)	25		
Connector Type	SMA-Male Standard (Other Connectors Available)		
Cable Length	300 cm Standard (Any Cable Length Available)		
Cable Type	D302 Standard (Other Cables Available)		

Antenna Measurement Conditions:

Mounted on 30 x 30 x 0.25 cm ABS Plate

200 cm of Cable D302

Measured in Certified CTIA 3D Anechoic Chamber

2. Mechanical and environmental specifications

Specifications	2J6924B
Mounting Type	Screw Mount
Dimensions (mm)	80 x 74 x 25.6
Max. Tighten Torque (Nm)	5 Nm
Radome Type	ABS UV Stable
Radome Color	Black, White
Operating Temperature (C)	-40 to +85
Storage Temperature (C)	-40 to +85
Substance Compliance	RoHS
Certificates	IP67, IP69

3. Antenna parameters

Cable 1: CELLULAR/LTE

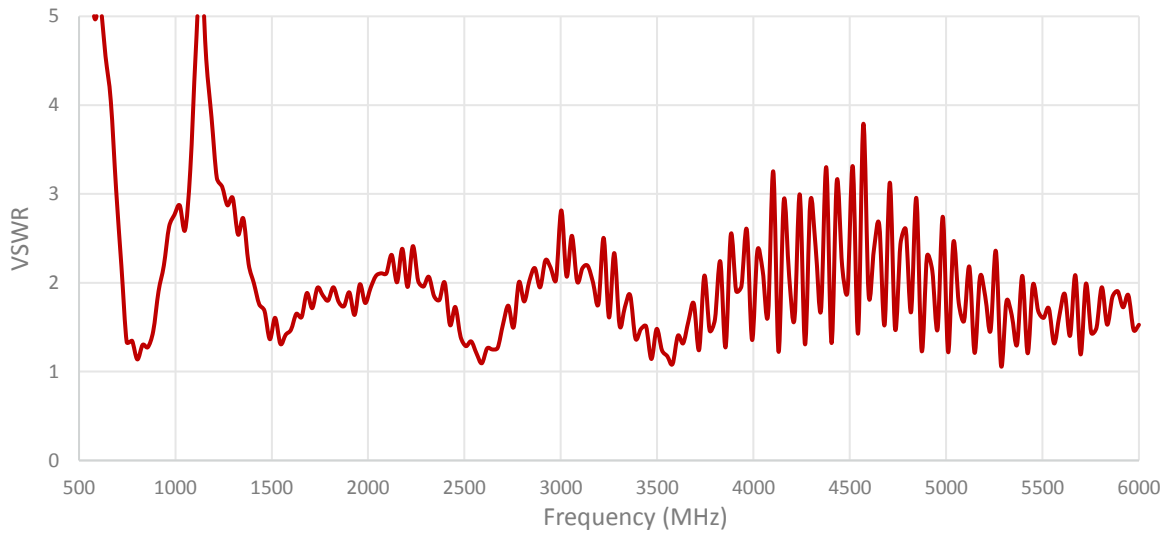
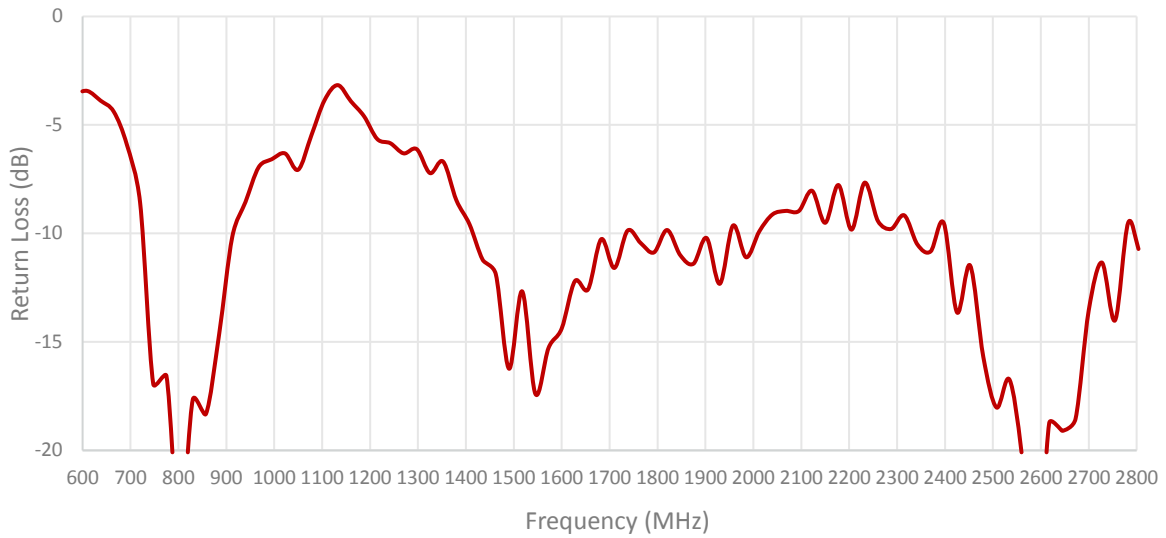

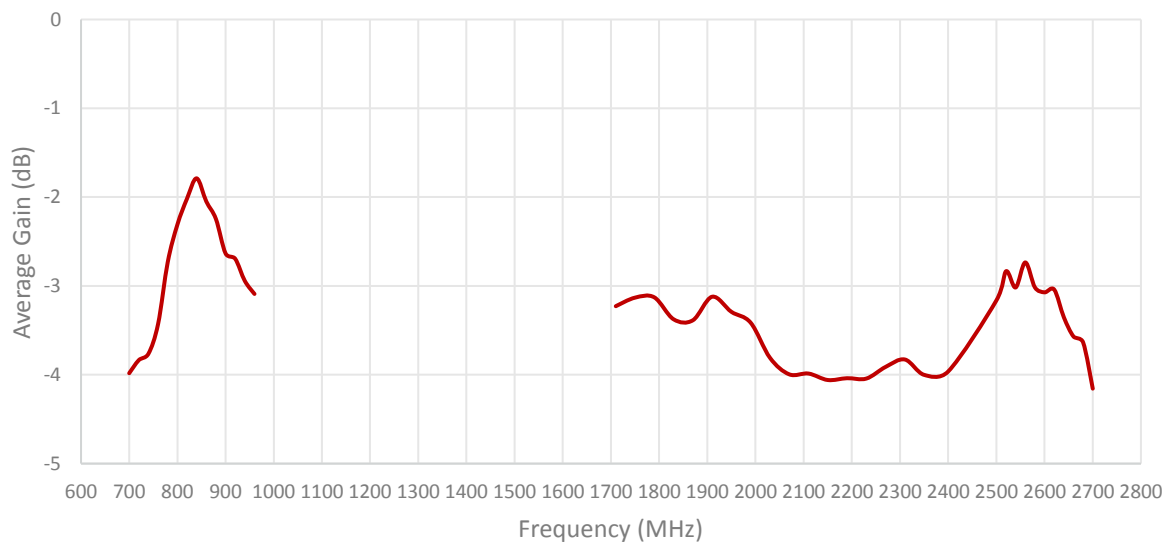
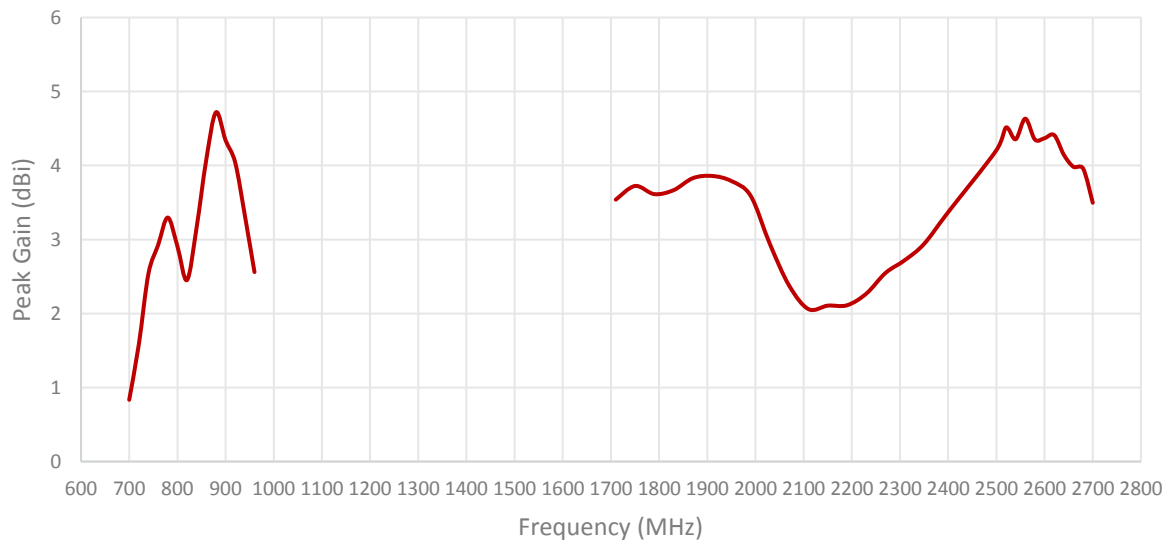
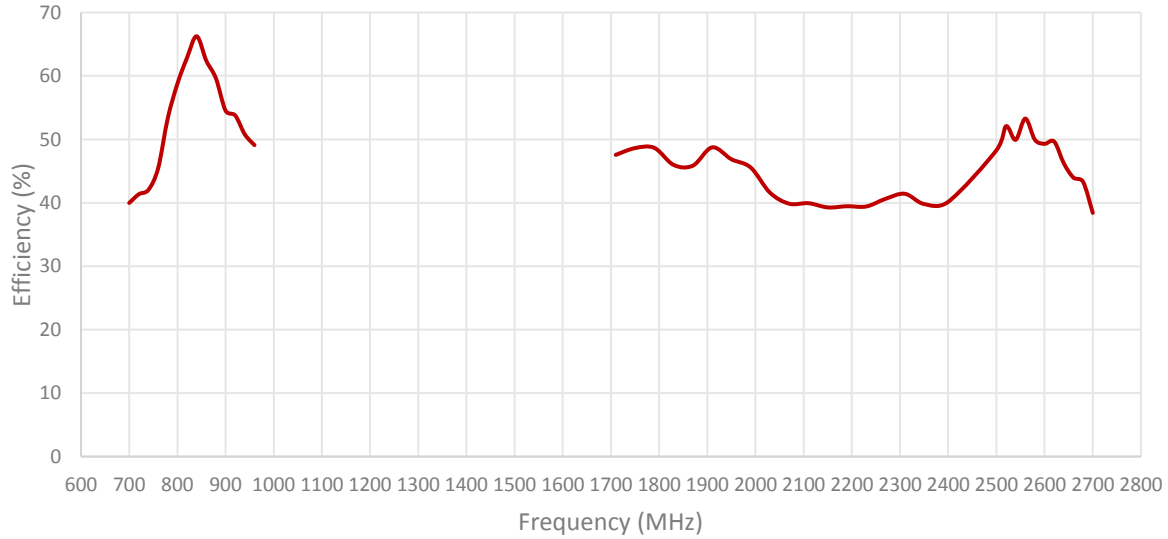

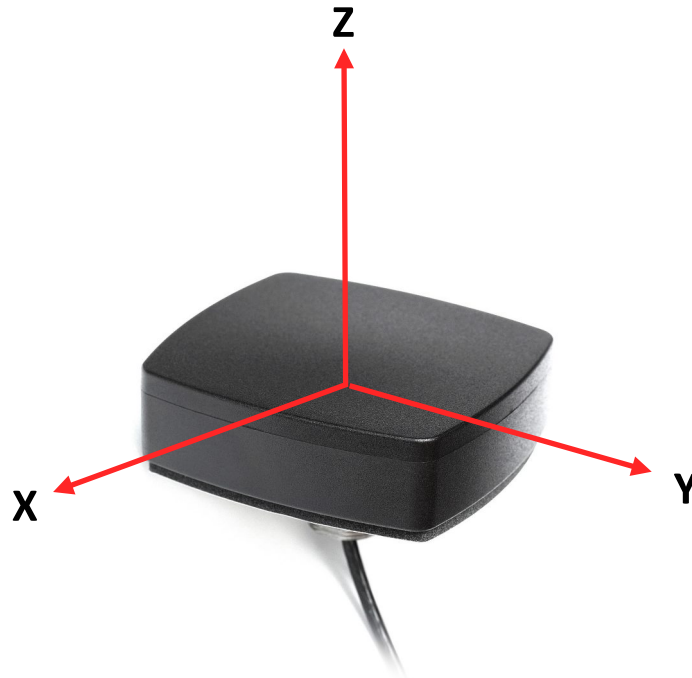

Radiation pattern reference

Table 1: CELLULAR/LTE

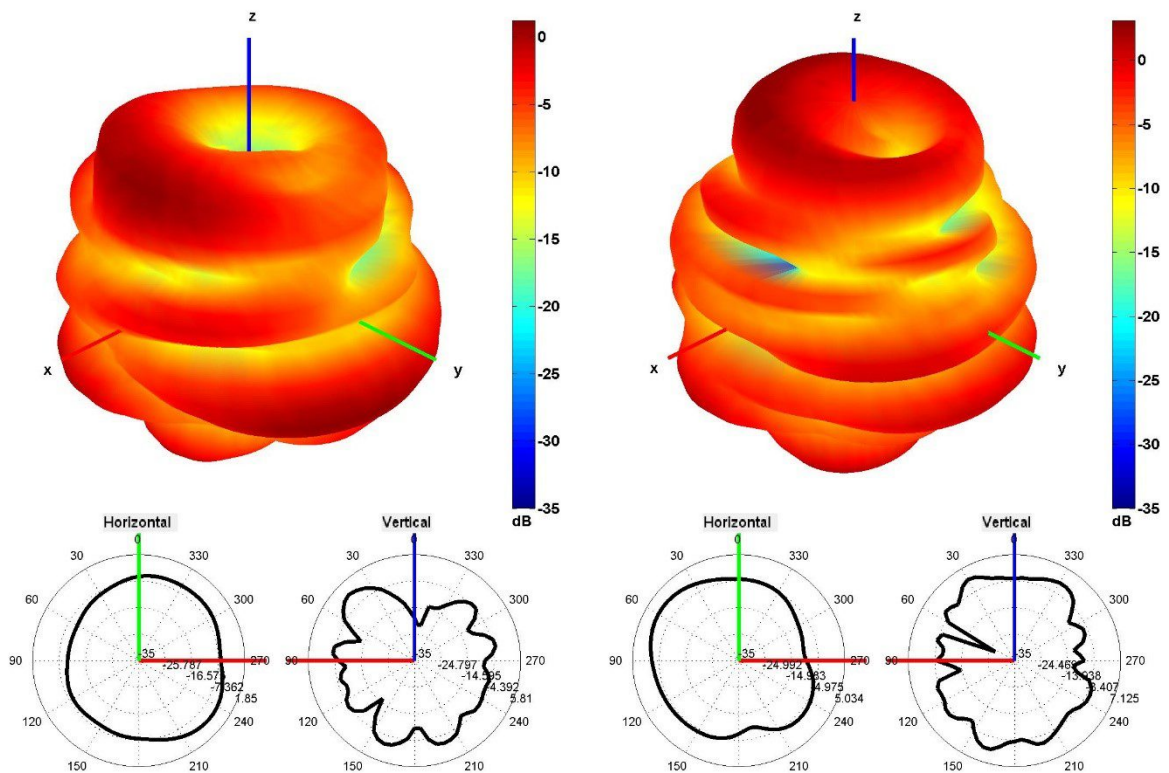

750 and 850 MHz Radiation pattern

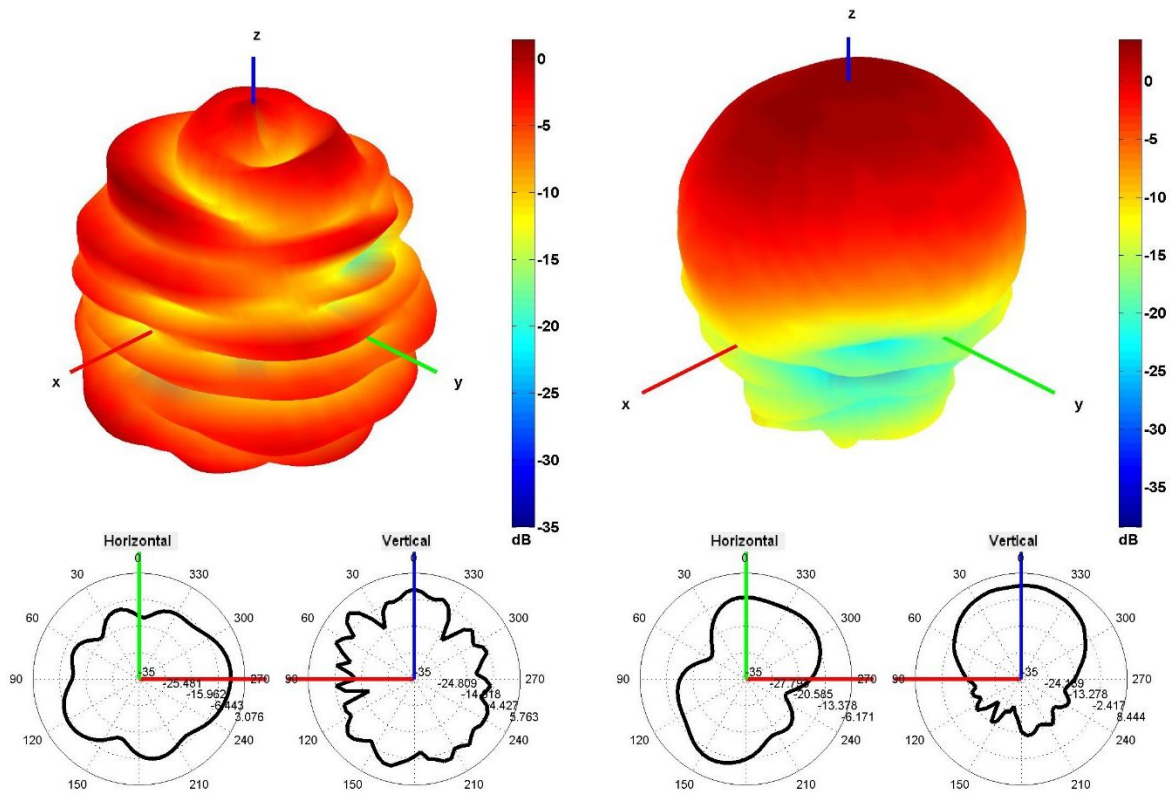

940 and 1750 MHz Radiation pattern

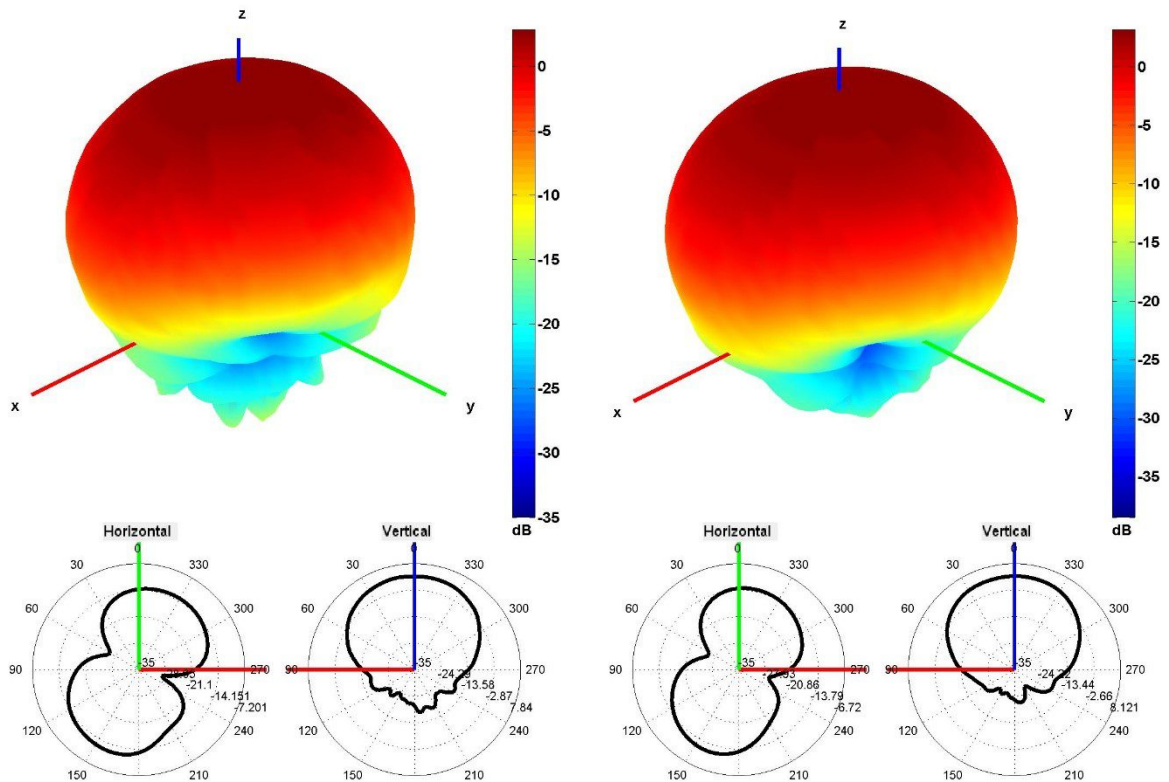

1850 and 1950 MHz Radiation pattern

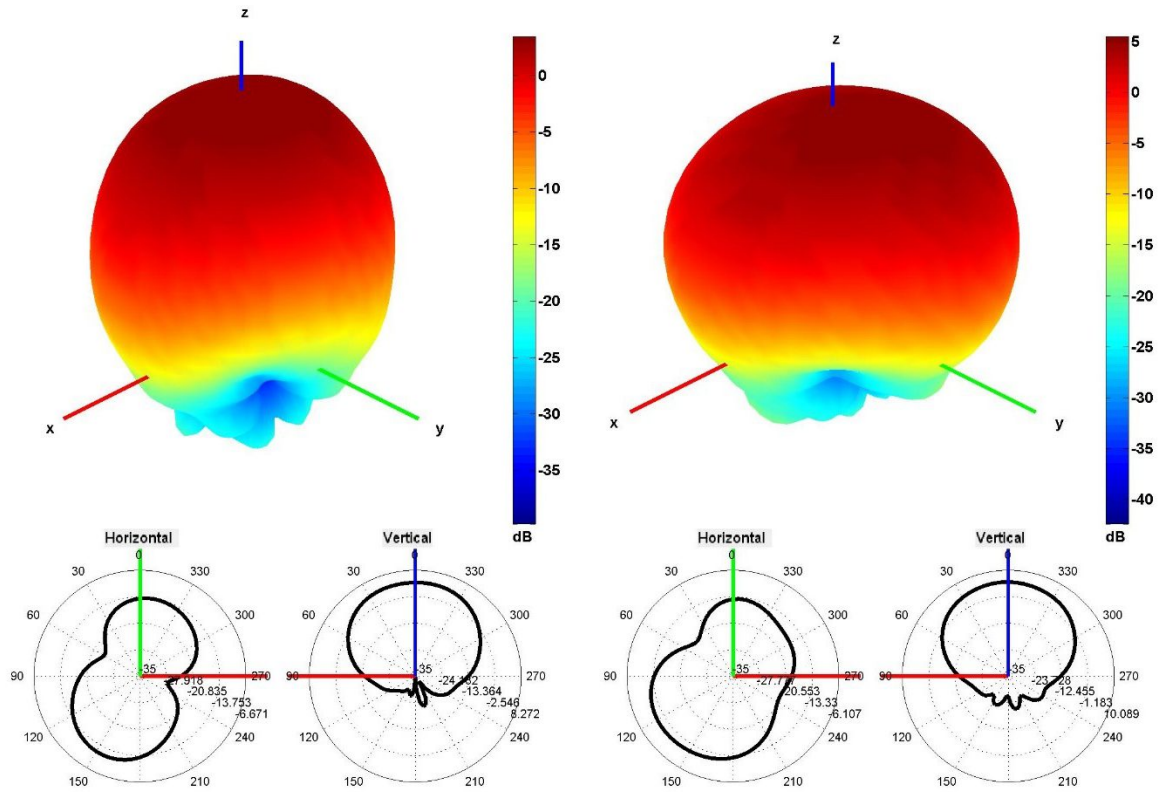

2100 and 2600 MHz Radiation pattern

4. Antenna drawings

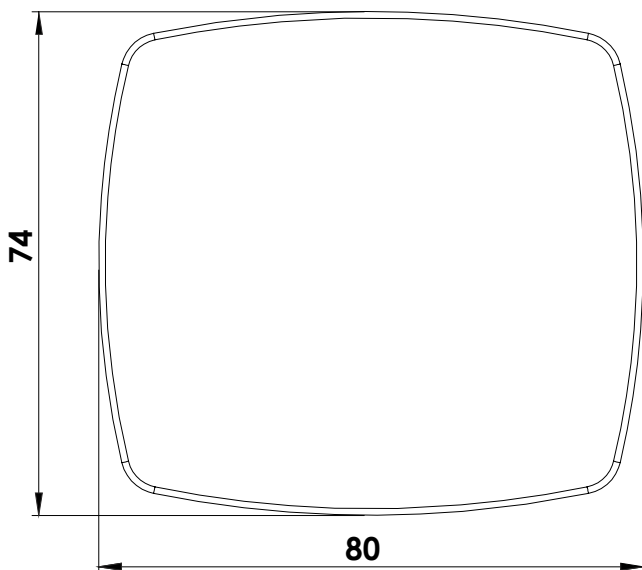
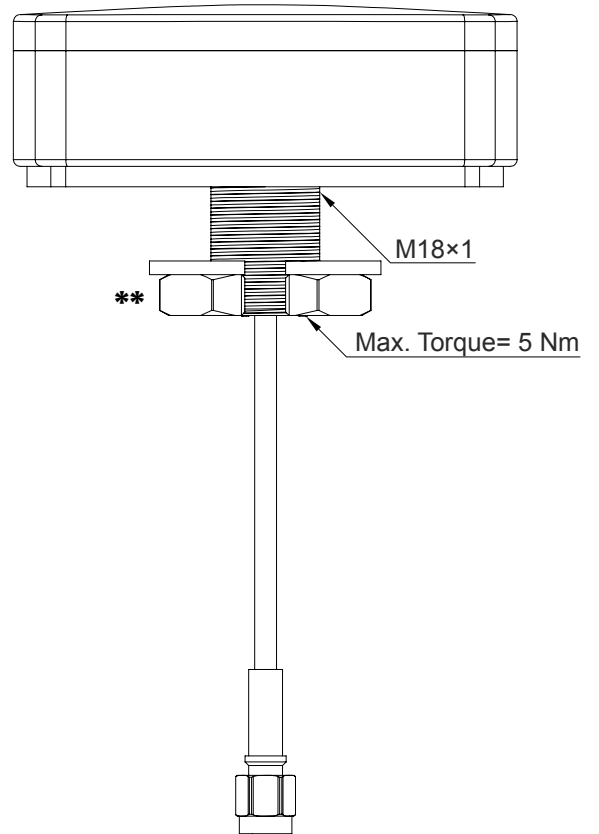
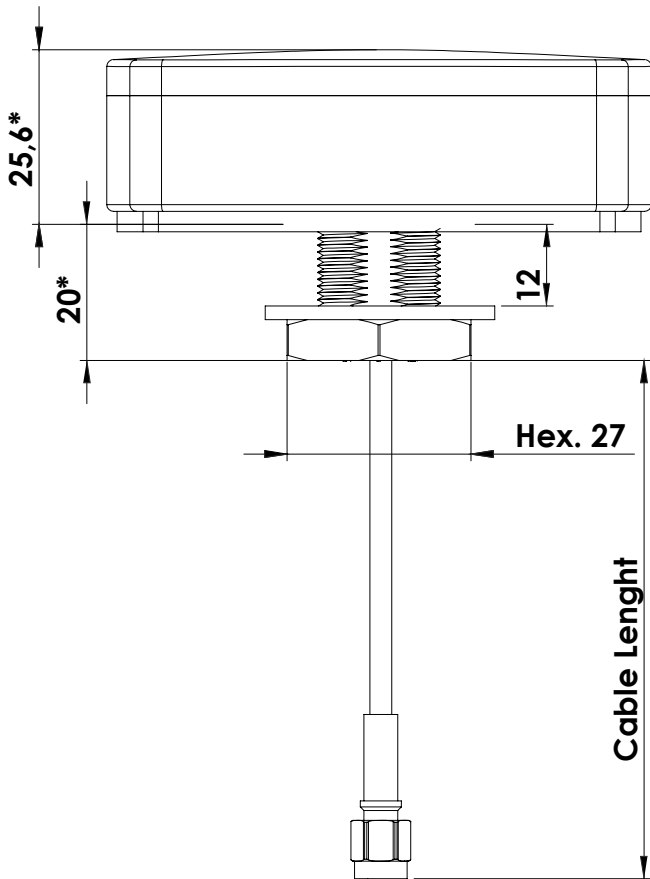

Mounting hole

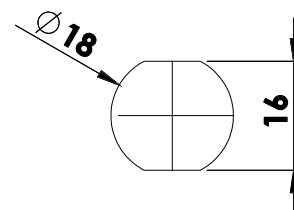

Max. mounting thickness 12mm
 Note: Dimensions are in millimeters
 *Dimensions are after mounting
 **Max. Torque= 5 Nm

5. Antenna Images





Макро Групп – это:

- дистрибьютор электронных компонентов с 1994 года
- контрактный производитель электроники с 2007 года с собственным производством в Санкт-Петербурге (компания Макро EMC, входит в ГК Макро Групп)
- поставщик полупроводниковых материалов
- комплексный поставщик электронных компонентов
- моделирование и производство полупроводниковых эпитаксиальных гетероструктур для задач оптоэлектроники

Головной офис расположен в Санкт-Петербурге. Собственные представительства в крупных промышленных городах России и стран СНГ.

Преимущества для наших заказчиков:

- работа по тендерам с 2012 года
- оформление банковских гарантий
- отсрочки платежей
- поставка электронных компонентов по проектным ценам
- инженерная поддержка проектов заказчиков
- сертификат системы менеджмента качества ISO 9001-2015
- необходимые сертификаты и лицензии

Данный файл получен с сайта www.macrogroup.ru