

For reference only. See data sheet for the detailed specifications.

Technical Specification

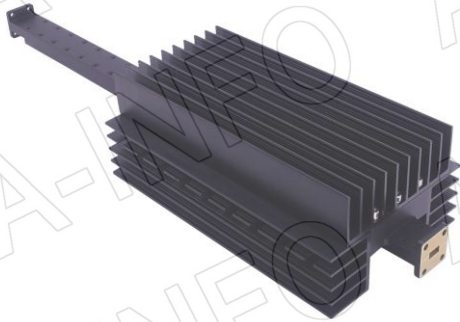

EIA WR	WR28
Frequency Range(GHz)	26.5 – 40.0
Attenuation(dB)	30
Attenuation Accuracy(dB)	±1.0 Max.
Attenuation Sensitivity(dB)	±0.9 Max.
VSWR	1.20:1 Max.
Power Handling(W CW)	500
Peak Power(KW)	100
Flange	FBP320(UBR320)
Material	Al
Size(mm)	327.7 x 90 x 57.9
Net Weight(Kg)	0.70 Around

Outline Drawing (Size: mm)

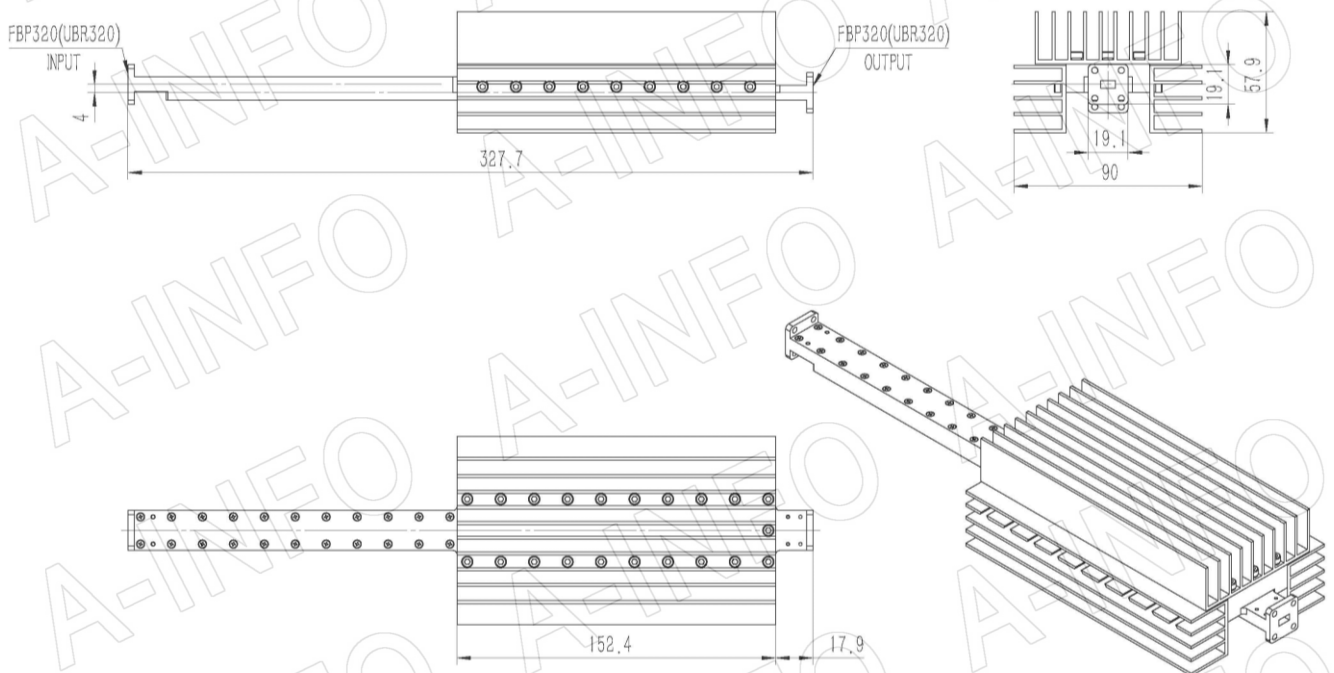

Flange Drawing (Size: mm)

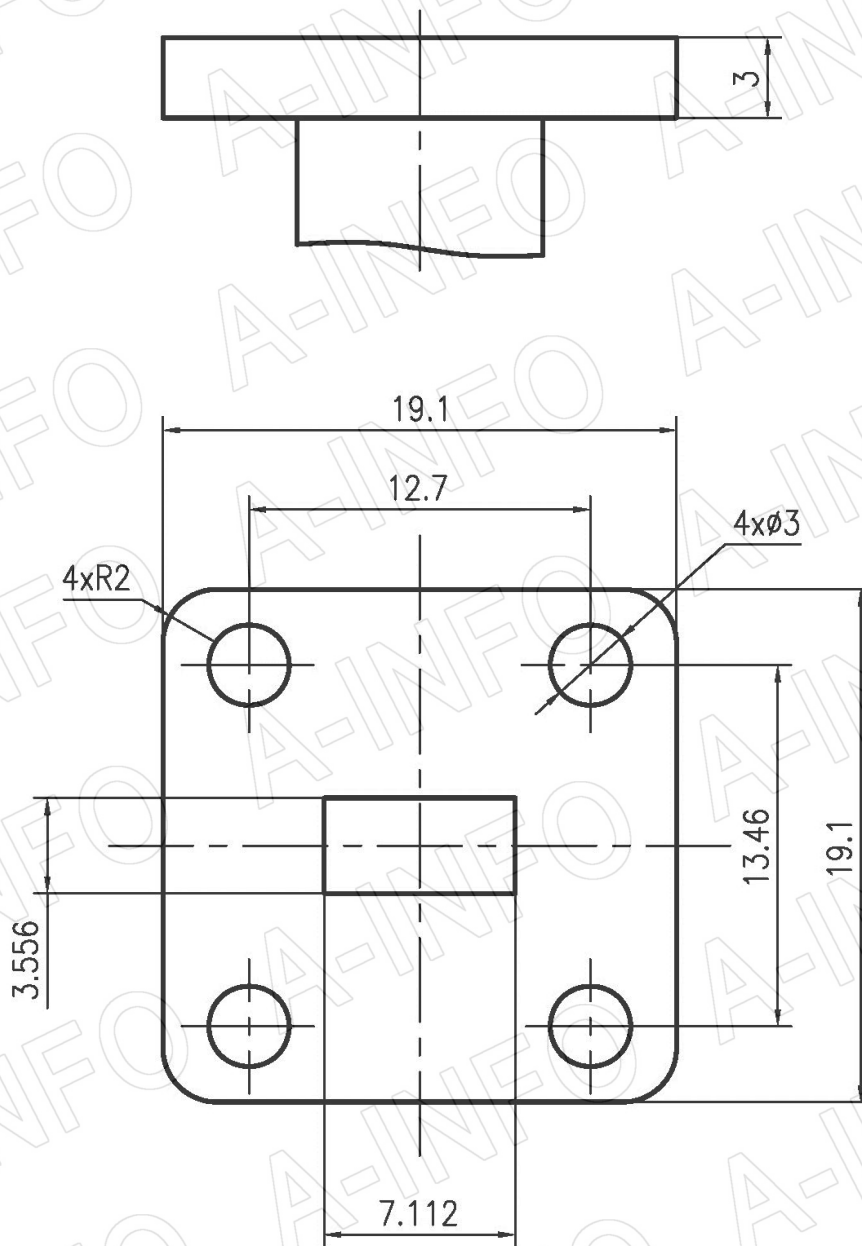

FBP320

AINFO Inc.

Page 2 of 3

China(Beijing): Tel: (+86) 10-6266-7326,
China(Chengdu): Tel: (+86) 28-8519-2786,
USA: Tel: (+1) 949-639-9688,

(+86) 10-6266-7327 Fax: (+86) 10-6266-7379
(+86) 28-8519-3044 Fax: (+86) 28-8519-3068
(+1) 949-639-9608 Fax: (+1) 949-639-9670

Website: www.ainfoinc.com
Email: sales@ainfoinc.com

Test Result

Attenuation & VSWR

