

Technical Specification

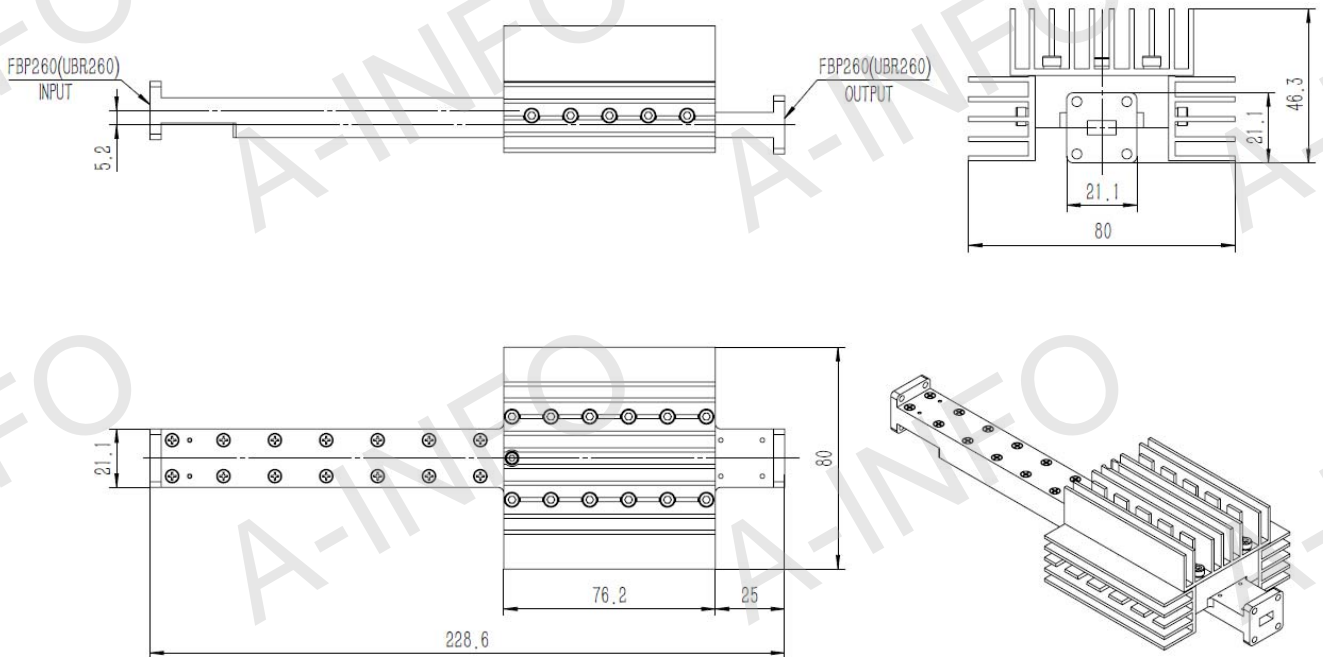

| | |
|-----------------------------|-------------------|
| EIA WR | WR34 |
| Frequency Range(GHz) | 22.0-33.0 |
| Attenuation(dB) | 20 |
| Attenuation Accuracy(dB) | ±1.0 Max. |
| Attenuation Sensitivity(dB) | ±0.9 Max. |
| VSWR | 1.2:1 Max. |
| Average Power(W) | 150 CW |
| Peak Power(KW) | 80 |
| Flange | FBP260(UBR260) |
| Material | Al |
| Size(mm) | 228.6 x 80 x 46.3 |
| Net Weight(Kg) | 0.35 Around |

Outline Drawing (Size: mm)



Flange Drawing (Size: mm)

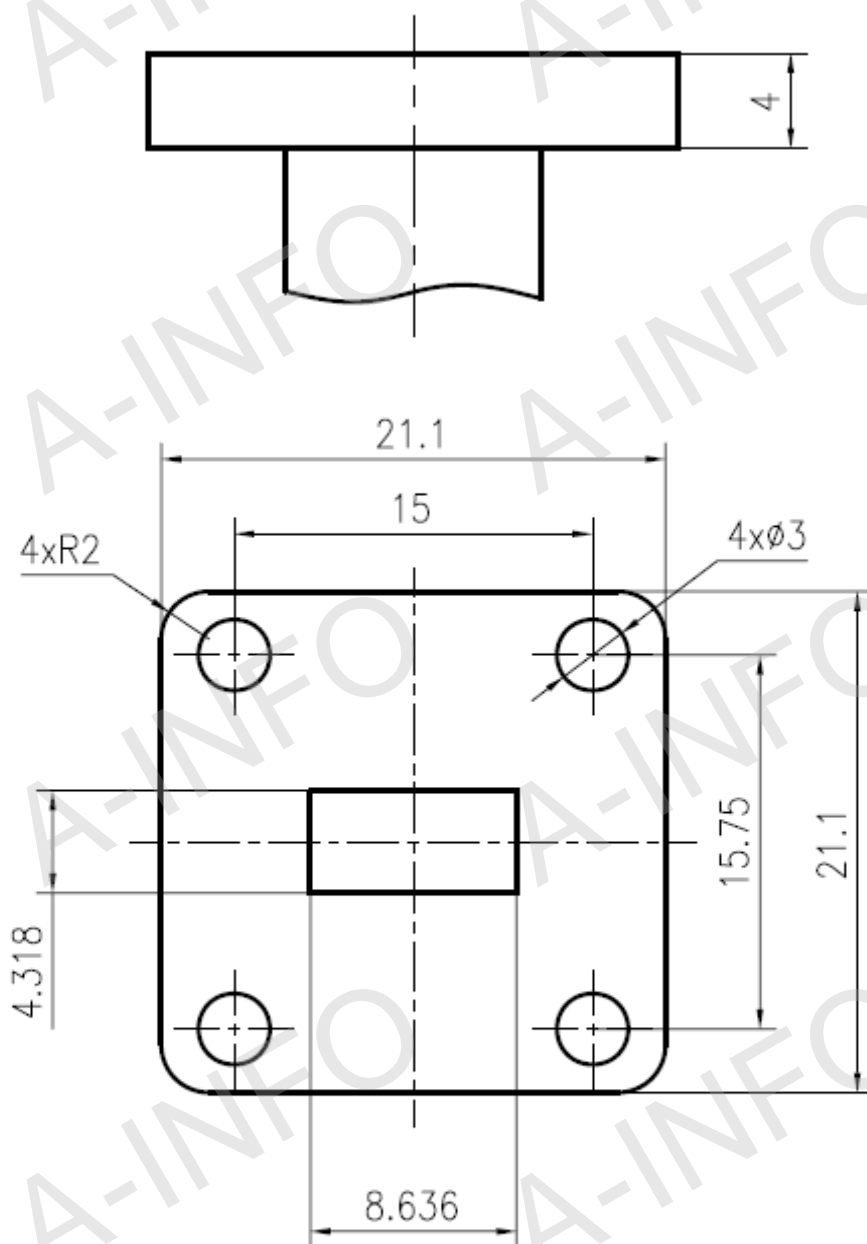

FBP260

AINFO Inc.

Page 2 of 3

China(Beijing):
China(Chengdu):
USA :

Tel: (+86) 10-6266-7326,
Tel: (+86) 28-8519-2786,
Tel: (+1) 949-639-9688,

(+86) 10-6266-7327
(+86) 28-8519-3044
(+1) 949-639-9608

Fax: (+86) 10-6266-7379
Fax: (+86) 28-8519-3068
Fax: (+1) 949-639-9670

Website: www.ainfoinc.com
Email: sales@ainfoinc.com

Test Results

Attenuation & VSWR

