

## 2JE08a

### GNSS Ceramic Surface Mount

#### Key Features

GPS/GLONASS/BeiDou/QZSS/Galileo

- 1561-1606 MHz

Surface Mount

Easy to Integrate

Compact size

Ceramic Material

Ground Plane Dependent

Dimensions 8 x 1.7 x 1 mm

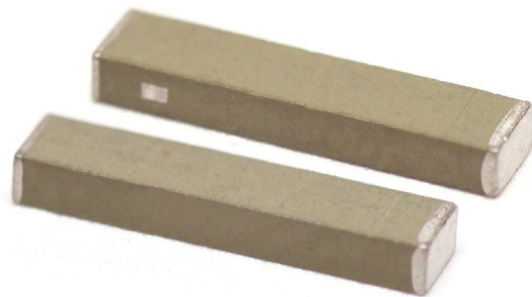

## 1. Antenna and electrical specifications

Parameters	GNSS Ceramic Thru-Hole Mount Antenna		
	BeiDou	GPS/QZSS/Galileo	GLONASS
<b>Standards</b>			
<b>Bands (MHz)</b>	1561	1575	1602
<b>Frequency (MHz)</b>	1561.098	1575.42	1598-1606
<b>Return Loss (dB)</b>	~-12.1	~-14.5	~-12.5
<b>VSWR</b>	~1.7:1	~1.5:1	~1.6:1
<b>Efficiency (%)</b>	~55.5	~56.9	~55.8
<b>Peak Gain (dBi)</b>	~1.0	~1.1	~1.3
<b>Average Gain (dB)</b>	~-2.6	~-2.5	~-2.5
<b>Impedance (Ohms)</b>		50	
<b>Radiation Pattern</b>		Hemispherical	
<b>Polarization</b>		Linear	

### Antenna Measurement Conditions:

Free Space

Mounted on Ground Plane of 50 x 90 mm

Measured in Certified CTIA 3D Anechoic Chamber

## 2. Mechanical and environmental specifications

Specifications	2JE08a
<b>Mounting Type</b>	Surface Mount
<b>Dimensions (mm)</b>	8 x 1.7 x 1
<b>Operating Temperature (C)</b>	-40 to +85
<b>Storage Temperature (C)</b>	-40 to +85
<b>Substance Compliance</b>	RoHS
<b>Typical Shear Force Test</b>	1KgF according to IEC62137-1-2:2007

### 3. Antenna parameters

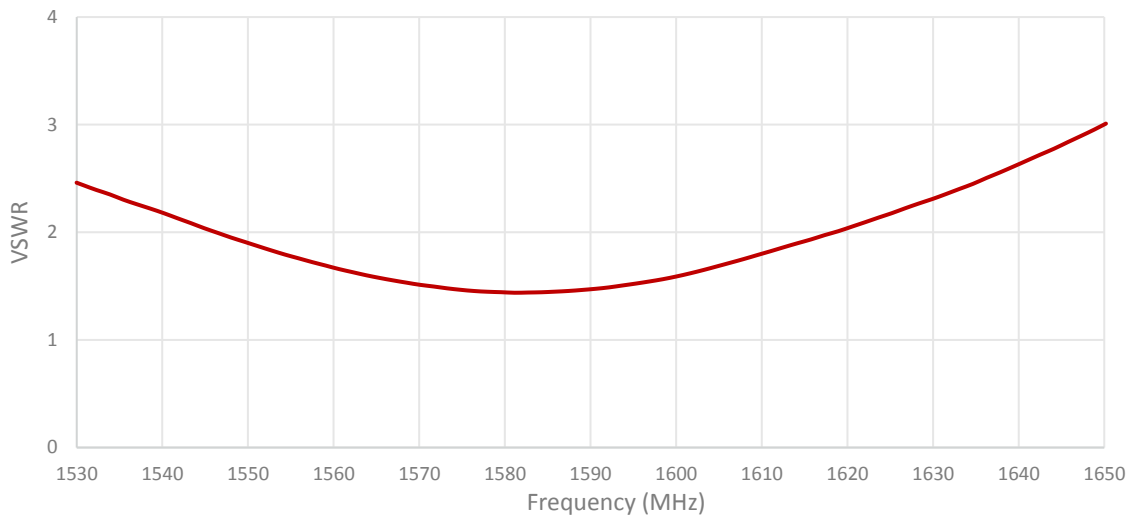
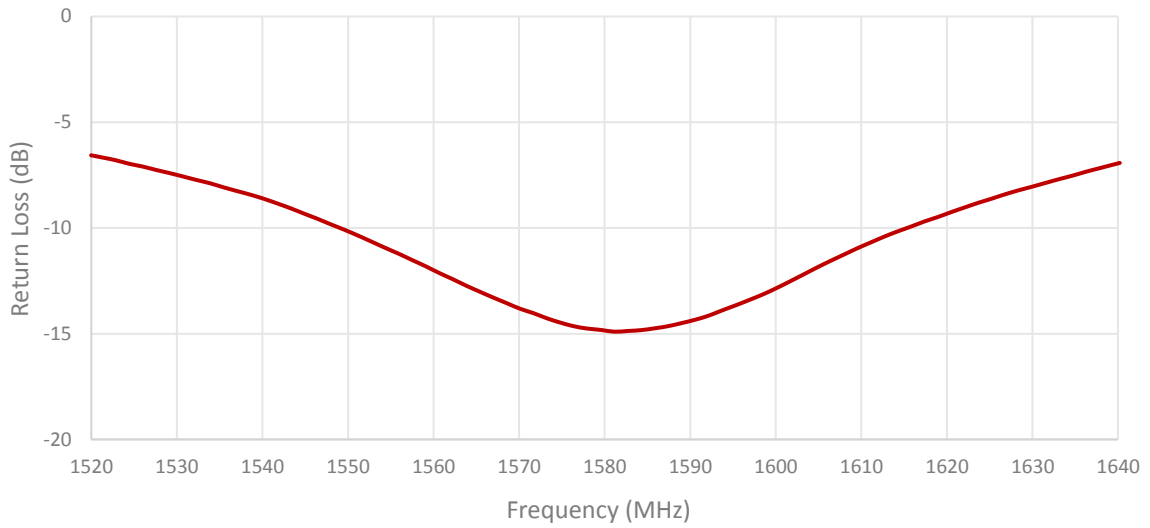

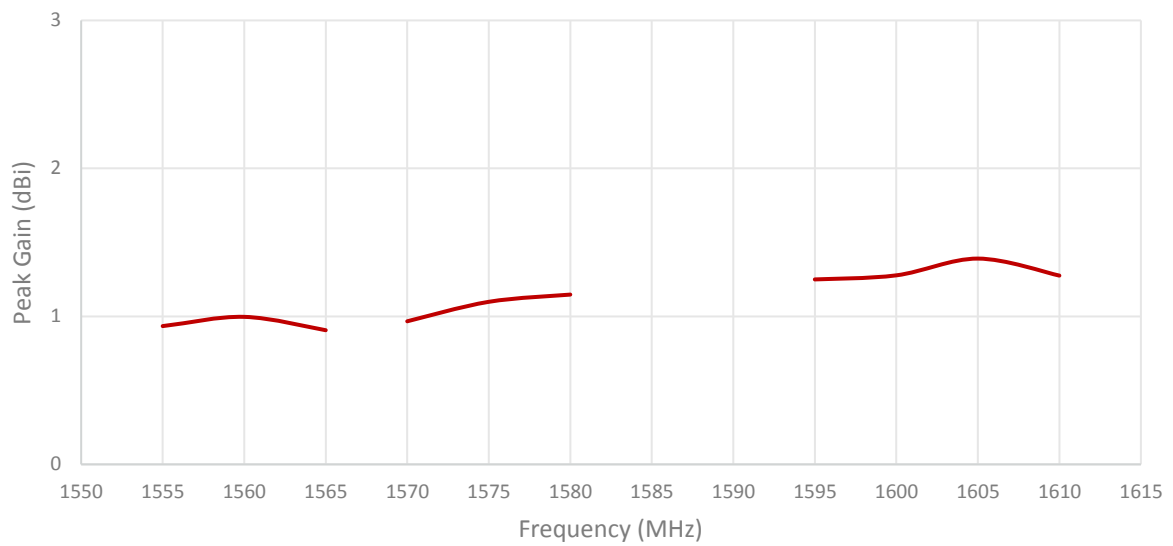
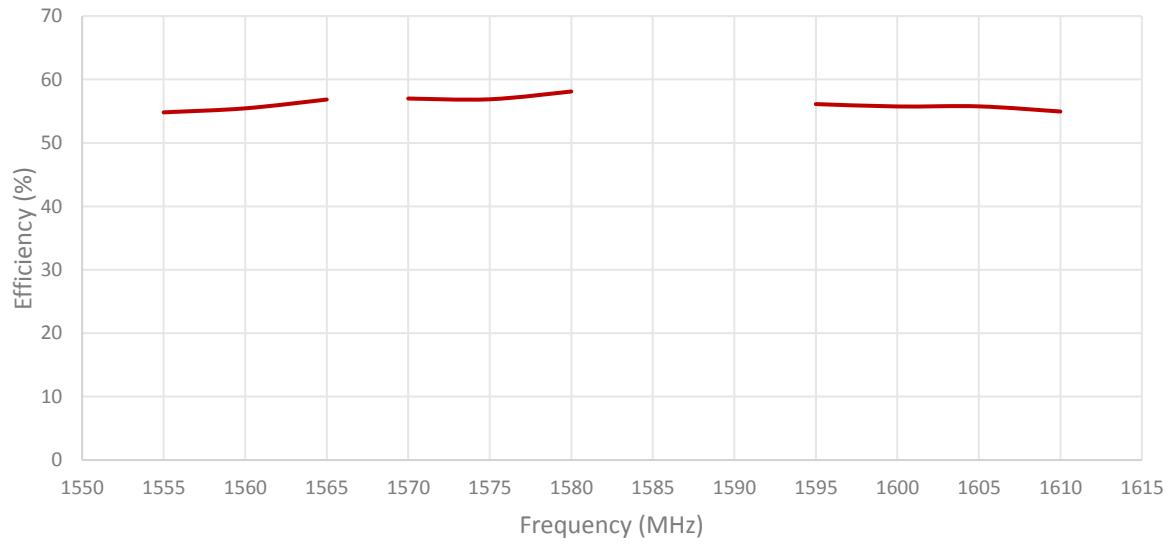

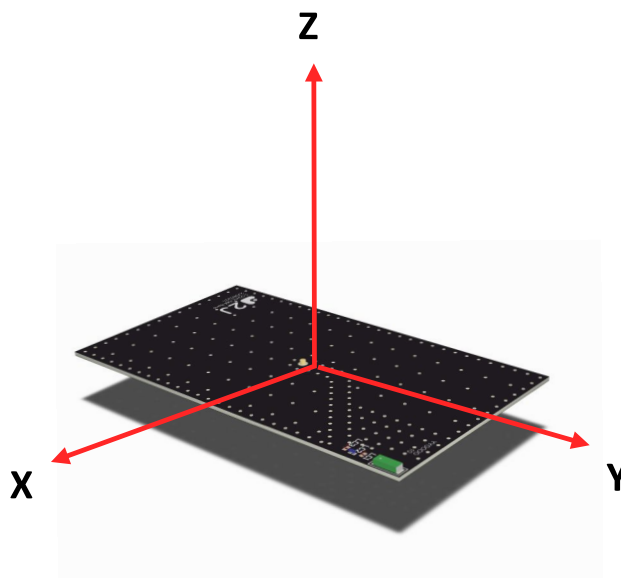
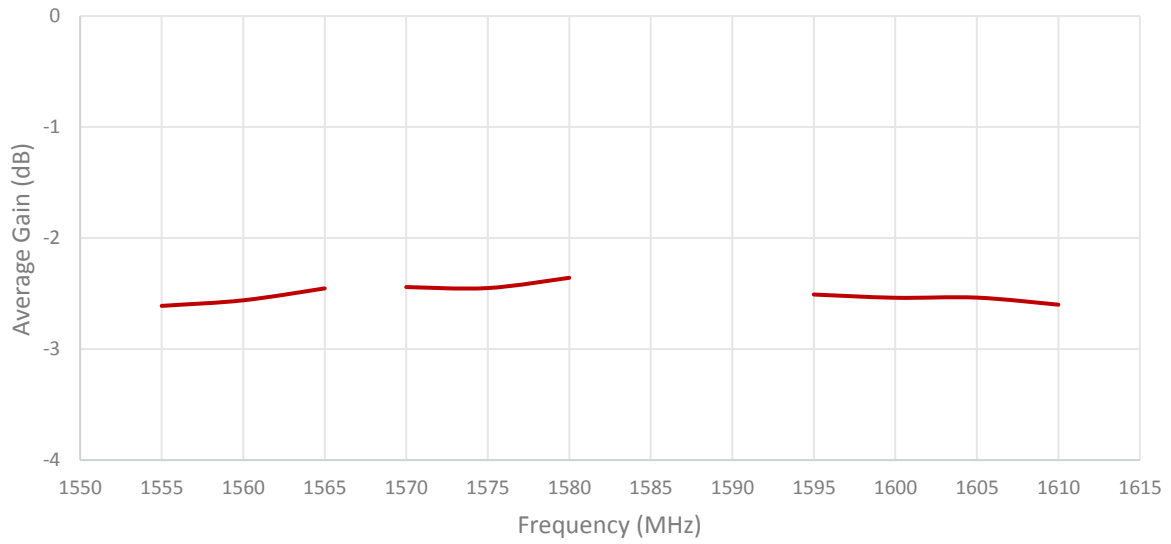

Radiation pattern reference

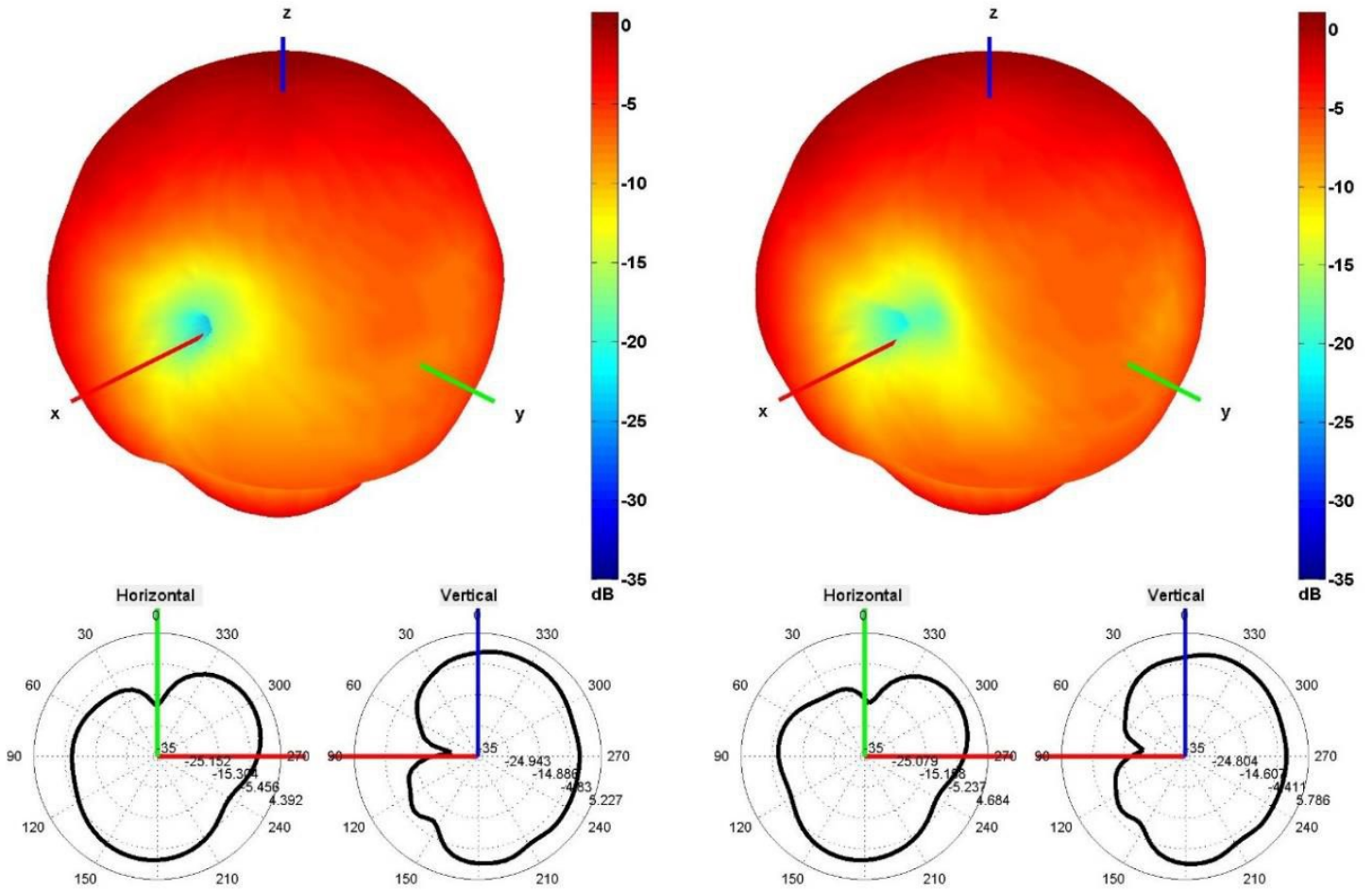

1561 AND 1575 MHz RADIATION PATTERN

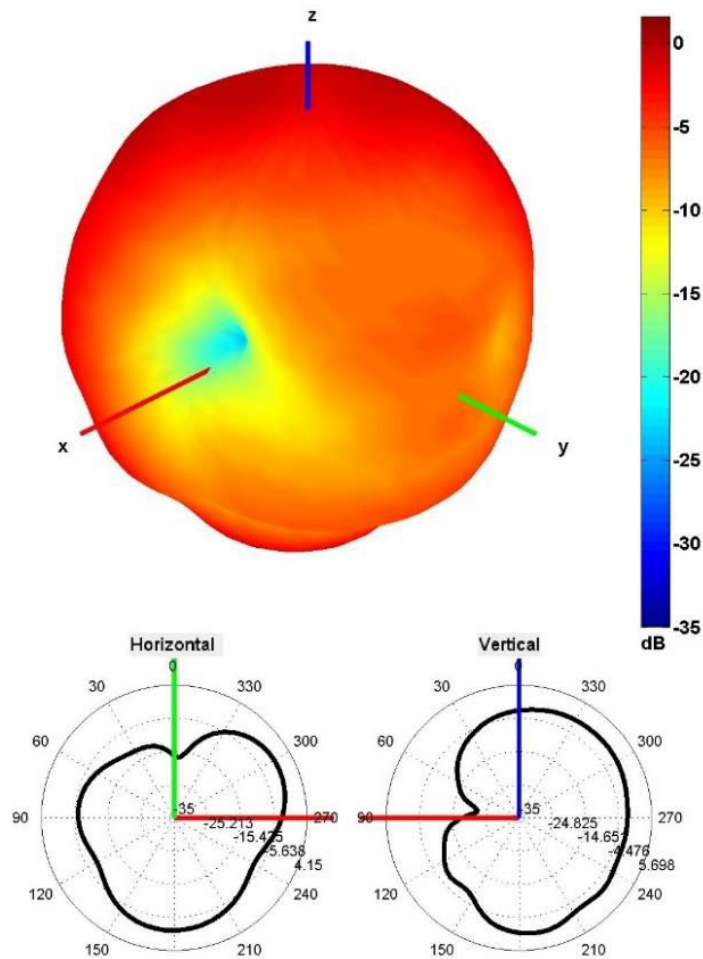

1602 MHz RADIATION PATTERN

## 4. PCB Layout

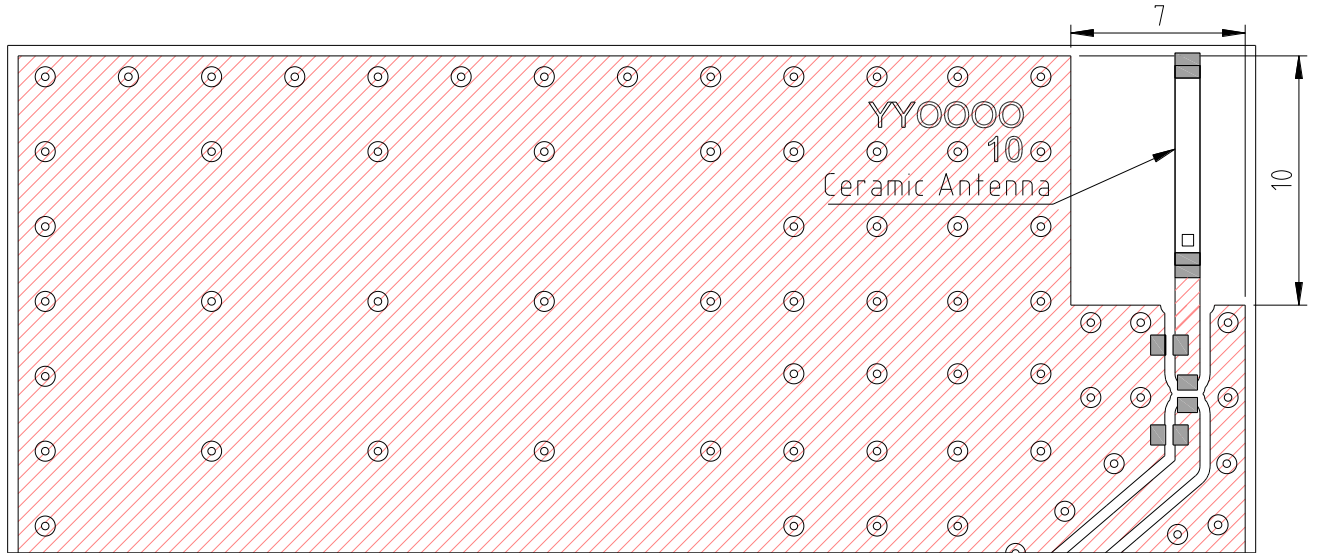

Minimum area required for antenna integration (7.0mm × 10.0mm)

- Solder Region
- Copper Region
- Copper-Free Region

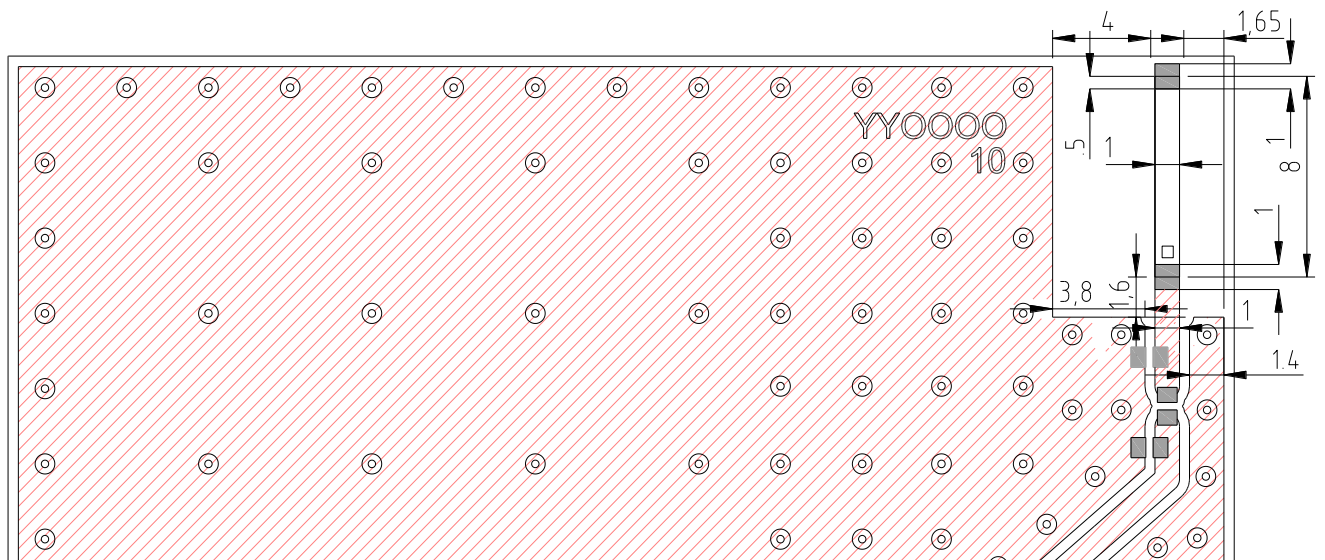

Layout dimensions for antenna integration (mm)

- Solder Region
- Copper Region
- Copper-Free Region



## 5. Matching Components

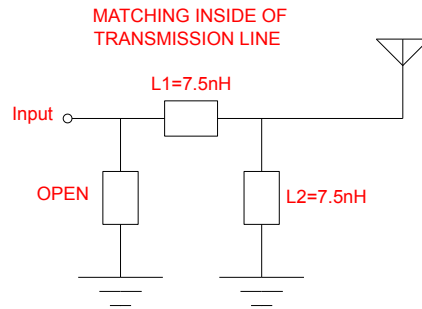

Matching Network Schematic

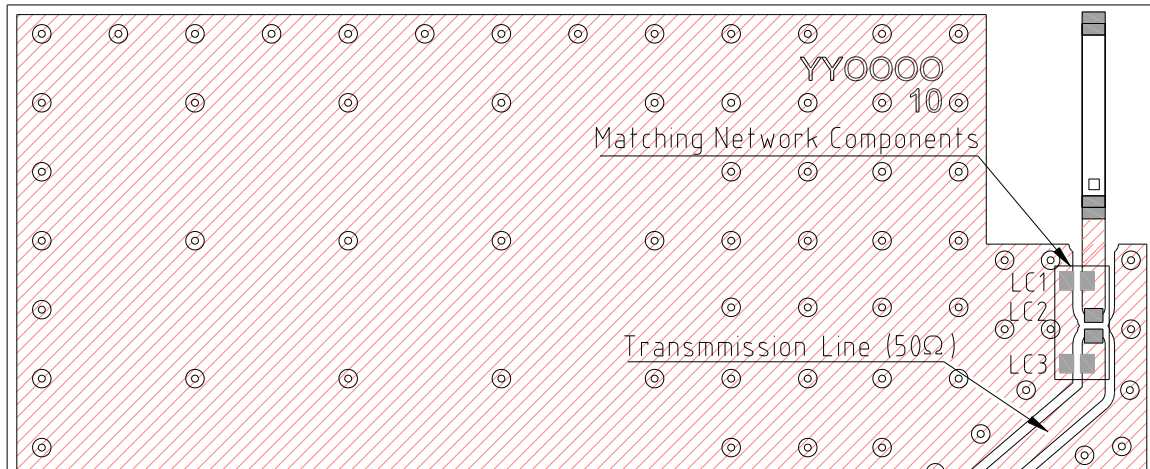

Matching network drawing (LC1=7.5pF, LC2=7.5nH, LC3=OPEN)

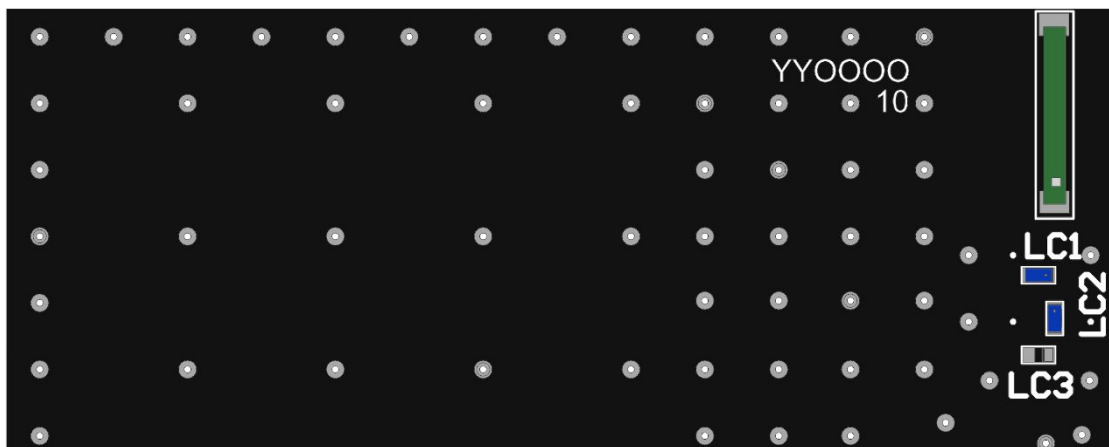

3D View of matching components and recommended values (LC1 = 7.5pF, LC2=7.5nH, LC3= OPEN)

**REFLOW TEMPERATURE PROFILE**

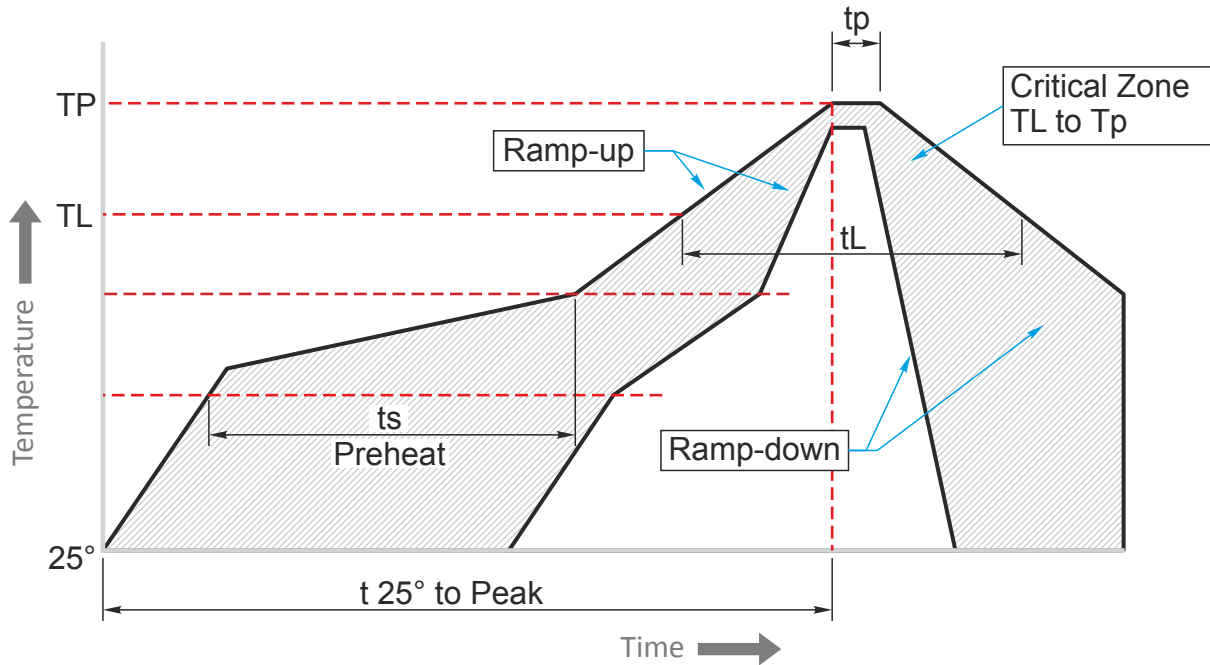

Phase	Profile features	Sn-Pb Assembly	Pb-Free Assembly (SnAgCu)
<b>RAMP-UP</b>	Avg. Ramp-up Rate ( $T_{s_{max}}$ to TP)	3°C / second (max)	3°C / second (max)
<b>PREHEAT</b>	-Temperature Min Rate ( $T_{s_{min}}$ ) -Temperature Max Rate ( $T_{s_{min}}$ ) -Time ( $t_{s_{min}}$ to $t_{s_{max}}$ )	100°C 150°C 60-120 seconds	150°C 200°C 60-120 seconds
<b>REFLOW</b>	-Temperature ( $T_r$ ) -Total Time above $T_r(t_r)$	183°C 60-150 seconds	217°C 60-150 seconds
<b>PEAK</b>	-Temperature ( $T_p$ ) -Time ( $t_p$ )	235°C 10-30 seconds	260°C 20-40 seconds
<b>RAMP-DOWN</b>	Rate	6°C / second max.	6°C / second max.
<b>Time from 25°C to Peak Temperature</b>		6 minutes max.	8 minutes max.

## 6. Evaluation Board

90mm x 50mm

90mm x 50mm

90mm x 50mm

90mm x 11.9mm  
(PCB: 0.8mm, Antenna: 1.6mm,  
Connector: 9.5mm)

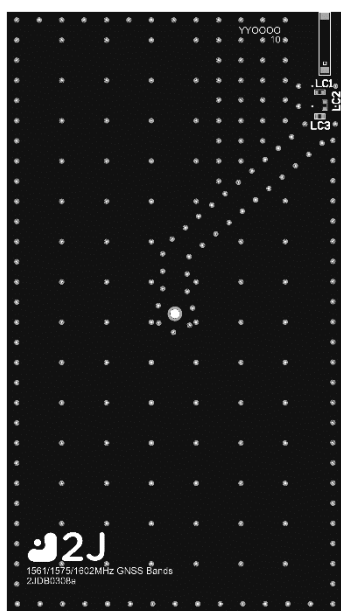

Front View without Antenna

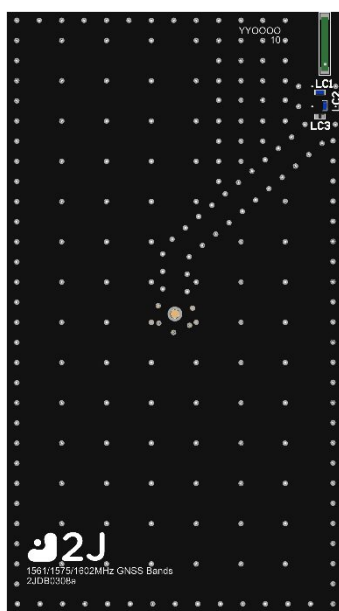

Front View with Antenna

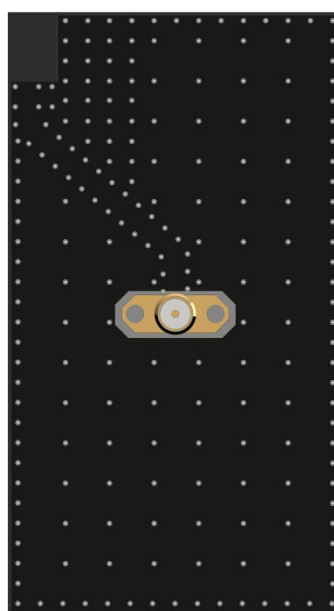

Back View

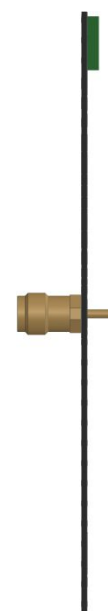

Side View

## 7. Antenna drawings

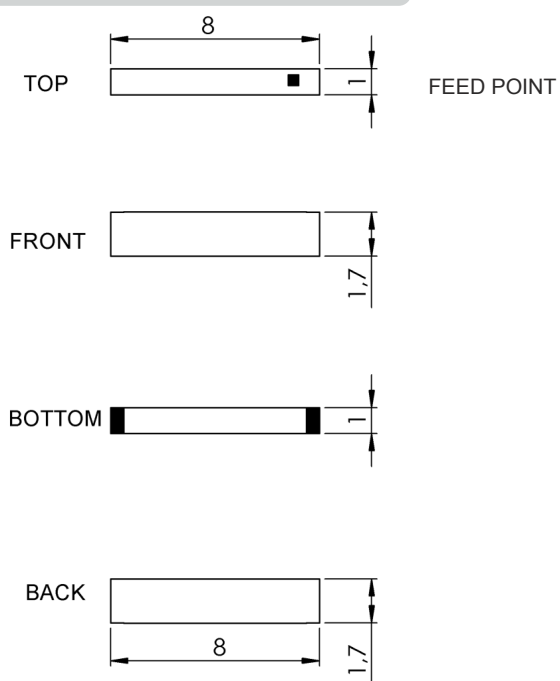

ceramic antenna body (mm)

## 8. Tape and Reel Information

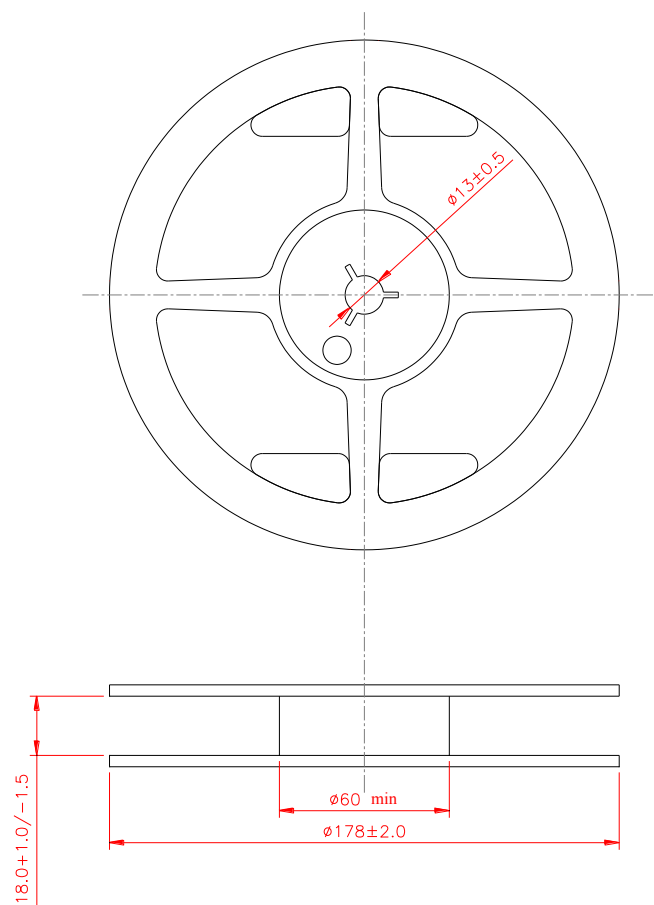
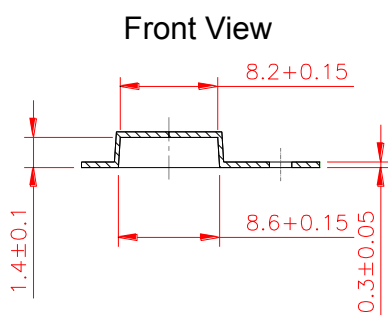
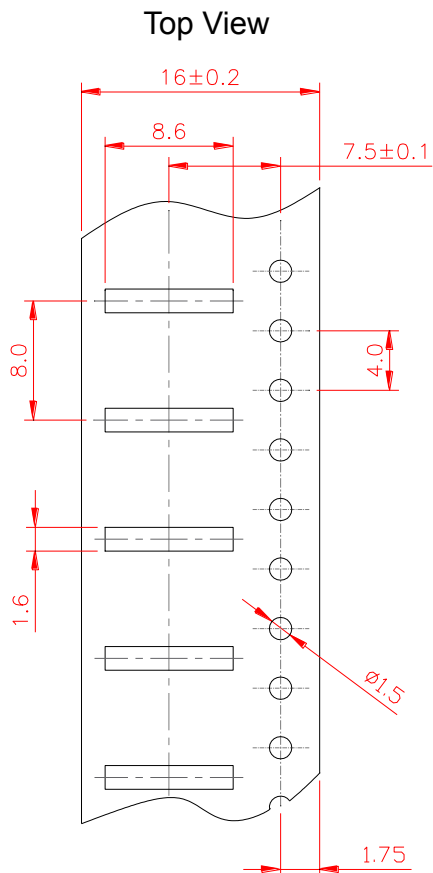

Tape and Reel Specifications

## 9. Packaging

### PACKAGING SPECIFICATION

<b>Antenna</b>	2JE08a
<b>REEL</b>	
<b>Max Quantity per Reel</b>	6000
<b>REEL BOX</b>	
<b>Reels per Box</b>	1
<b>Reel Box Dimensions (cm)</b>	18.5 x 18.5 x 3
<b>Reel Box Weight (Kg)</b>	0.27
<b>CARTON</b>	
<b>Reels per Carton</b>	10
<b>Max Quantity per Carton</b>	60,000
<b>Reel Carton Dimensions (cm)</b>	33 x 21 x 21
<b>Reel Carton Weight (Kg)</b>	3.1

### Storage Conditions:

- Storage Temperature Range: -40 °C to +85 °C
- Oxidizable material. Store for 12 months in vacuum sealed bag.
- Repack material after use by re-sealing package.

## 5. Antenna Images

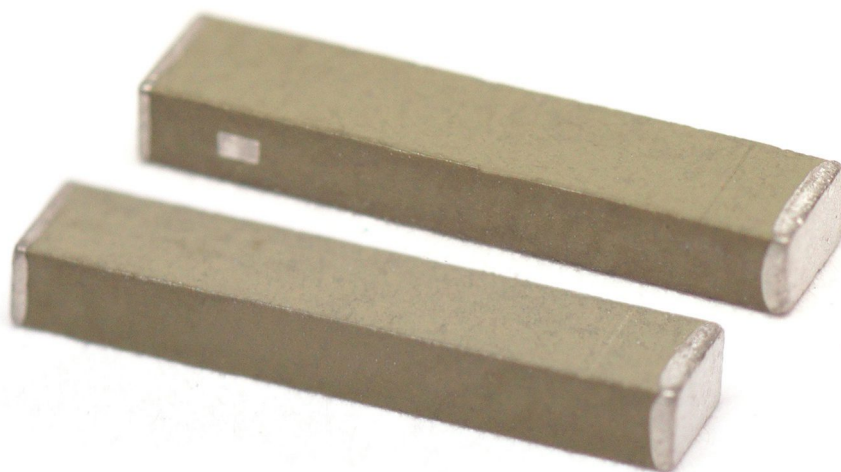



## Макро Групп – это:

- дистрибьютор электронных компонентов с 1994 года
- контрактный производитель электроники с 2007 года с собственным производством в Санкт-Петербурге (компания Макро EMC, входит в ГК Макро Групп)
- поставщик полупроводниковых материалов
- комплексный поставщик электронных компонентов
- моделирование и производство полупроводниковых эпитаксиальных гетероструктур для задач оптоэлектроники

Головной офис расположен в Санкт-Петербурге. Собственные представительства в крупных промышленных городах России и стран СНГ.

## Преимущества для наших заказчиков:

- работа по тендерам с 2012 года
- оформление банковских гарантий
- отсрочки платежей
- поставка электронных компонентов по проектным ценам
- инженерная поддержка проектов заказчиков
- сертификат системы менеджмента качества ISO 9001-2015
- необходимые сертификаты и лицензии

Данный файл получен с сайта [www.macrogroup.ru](http://www.macrogroup.ru)