

For reference only. See data sheet for the detailed specifications.

## Technical Specification



EIA WR	WR28
Frequency Range(GHz)	26.5 – 40.0
Attenuation(dB)	20
Attenuation Accuracy(dB)	±1.0 Max.
Attenuation Sensitivity(dB)	±0.9 Max.
VSWR	1.20:1 Max.
Average Power(W CW)	125
Peak Power(KW)	50
Flange	FBP320(UBR320)
Material	Al
Size(mm)	254 x 80 x 45.8
Net Weight(Kg)	0.36 Around

## Outline Drawing (Size: mm)

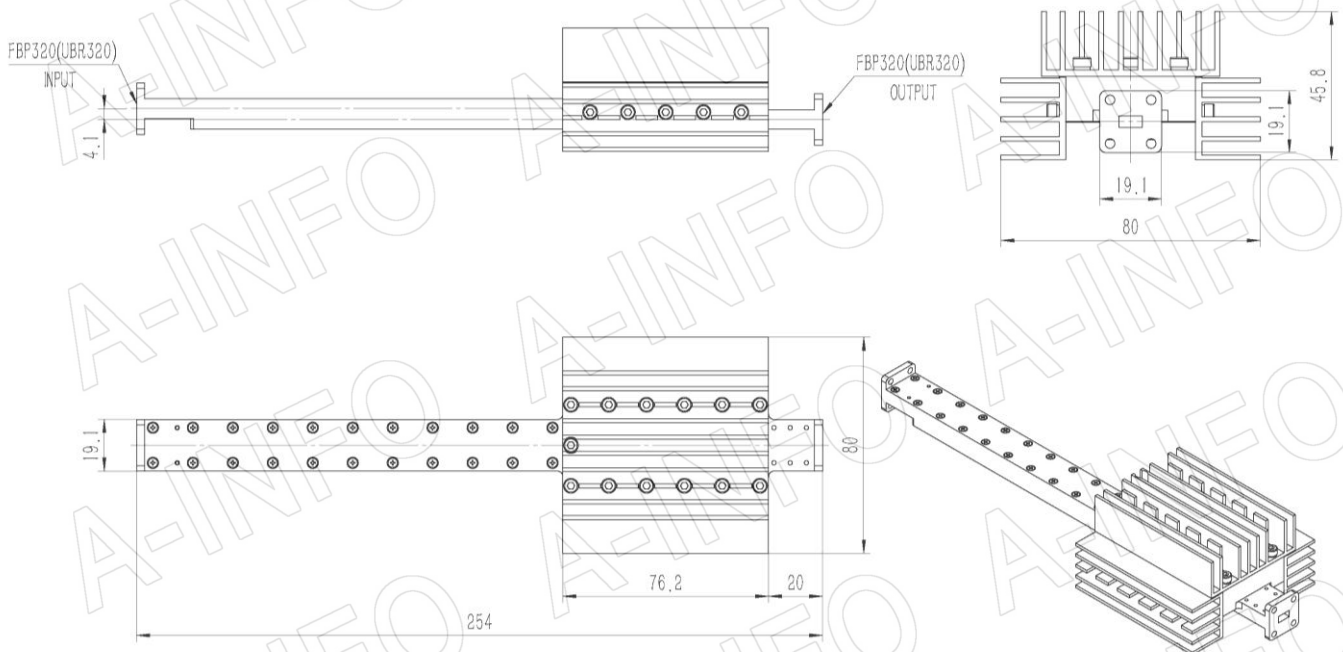

**AINFO Inc.**

China(Beijing): Tel: (+86) 10-6266-7326,  
 China(Chengdu): Tel: (+86) 28-8519-2786,  
 USA: Tel: (+1) 949-639-9688,

Page 1 of 3

(+86) 10-6266-7327 Fax: (+86) 10-6266-7379  
 (+86) 28-8519-3044 Fax: (+86) 28-8519-3068  
 (+1) 949-639-9608 Fax: (+1) 949-639-9670

Website: [www.ainfoinc.com](http://www.ainfoinc.com)  
 Email: [sales@ainfoinc.com](mailto:sales@ainfoinc.com)

## Flange Drawing (Size: mm)

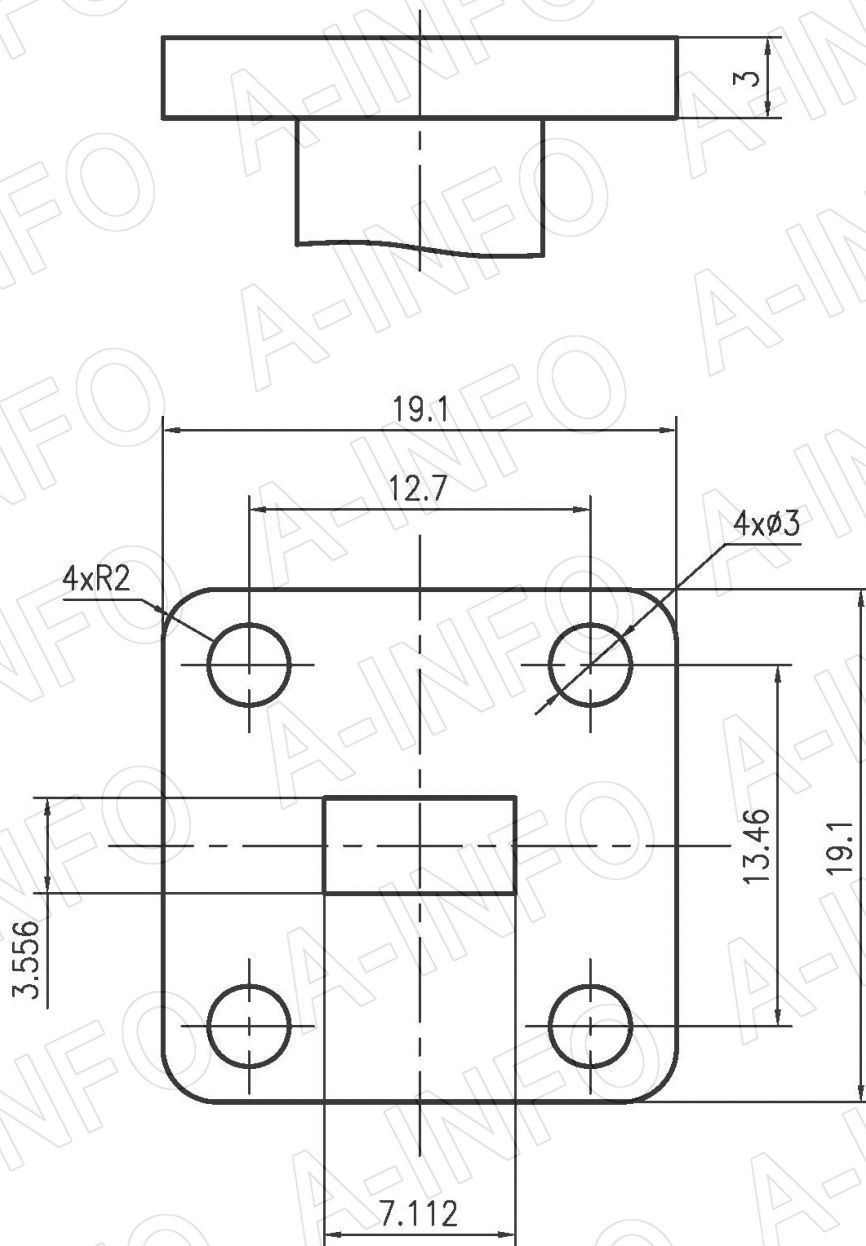

### FBP320

**AINFO Inc.**

China(Beijing): Tel: (+86) 10-6266-7326,  
China(Chengdu): Tel: (+86) 28-8519-2786,  
USA: Tel: (+1) 949-639-9688,

Page 2 of 3

(+86) 10-6266-7327 Fax: (+86) 10-6266-7379  
(+86) 28-8519-3044 Fax: (+86) 28-8519-3068  
(+1) 949-639-9608 Fax: (+1) 949-639-9670

Website: [www.ainfoinc.com](http://www.ainfoinc.com)  
Email: [sales@ainfoinc.com](mailto:sales@ainfoinc.com)

## Test Result

### Attenuation & VSWR

