

Technical Specification

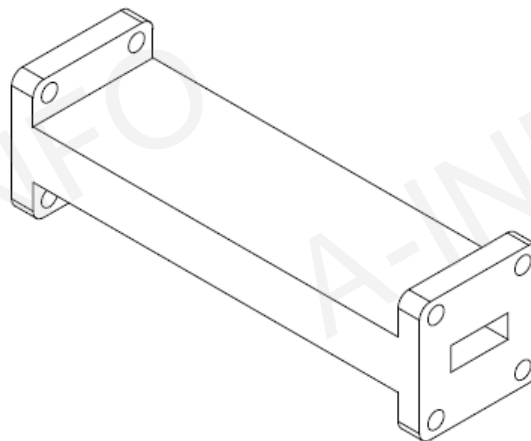

EIA WR	WR42
Frequency Range(GHz)	18.0-26.5
Attenuation(dB)	10
Accuracy(dB)	±1.5 Max.
VSWR	1.25 Max.
Flange	FBP220(UBR220)
Power Handling(W)	2
Material	Cu
Net Weight(Kg)	0.1 Around

Outline Drawing (Size: mm)

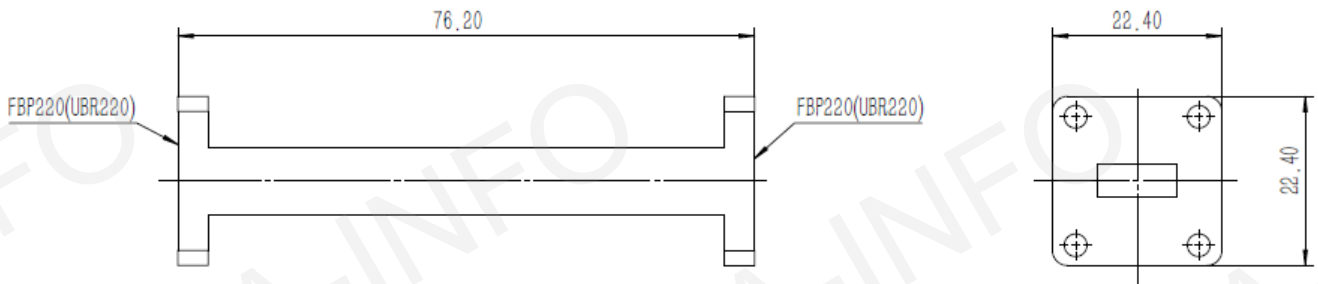

Flange Drawing (Size: mm)

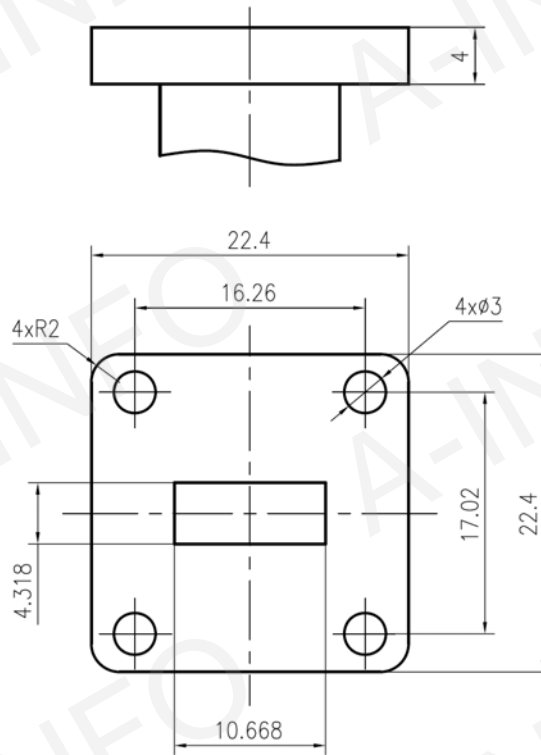

FBP220

Test Results

