

Silicon Carbide (SiC) MOSFET use a completely new technology that provide superior switching performance and higher reliability compared to Silicon. In addition, the low ON resistance and compact chip size ensure low capacitance and gate charge. Consequently, system benefits include highest efficiency, faster operating frequency, increased power density, reduced EMI, and reduced system size.

Features

- High Speed Switching with Low Capacitances
- High Blocking Voltage with Low RDS(on)
- Optimized package with separate driver source pin
- Easy to parallel and simple to drive
- ROHS Compliant, Halogen free

Application

- EV motor drive
- High Voltage DC/DC Converters
- Switch Mode Power Supplies
- Solar inverters
- EV charging

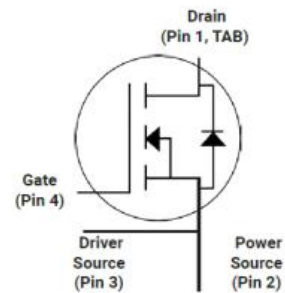
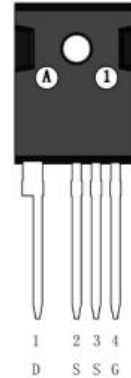

Ordering Information

Part Number	Marking	Package	Packaging
A2G100N1700MT4	A2G100N1700MT4	TO-247-4	Tube

Absolute Maximum Ratings(Tc=25°C)

Symbol	Parameter	Value	Unit
V _{DS}	Drain-Source Voltage	1700	V
I _D	Drain Current(continuous)at Tc=25°C	100	A
I _D	Drain Current(continuous)at Tc=100°C	75	A
I _{DM}	Drain Current (pulsed)	200	A
V _{GS}	Gate-Source Voltage	-10/+22V	V
P _D	Power Dissipation T _C = 25°C	484	W
T _J , T _{stg}	Junction and Storage Temperature Range	-55 to +175	°C

Electrical Characteristics(T_J = 25°C unless otherwise specified)
Typical Performance-Static

Symbol	Parameter	Test Conditions	Min.	Typ.	Max.	Unit
BV _{DS}	Drain-source Breakdown Voltage	I _D =250uA, V _{GS} =0V	1700			V
I _{DSS}	Zero Gate Voltage Drain Current	V _{DS} =1700V, V _{GS} =0V, T _J =25°C		5	100	uA
I _{GSS}	Gate-body Leakage Current	V _{DS} =0V ; V _{GS} =-5 to 20V		10	250	nA
V _{GS(th)}	Gate Threshold Voltage	V _{DS} = V _{GS} , I _D =10mA	2	3	4	V
V _{GS(on)}	Recommended turn-on Voltage	Static		18		V
V _{GS(off)}	Recommended turn-off Voltage			-5		V
R _{DS(on)}	Static Drain-source On Resistance	V _{GS} =18V, I _D =50A		26	30	mΩ
		V _{GS} =18V, I _D =50A T _J =175°C		44		mΩ

Typical Performance-Dynamic

Symbol	Parameter	Test Conditions	Min.	Typ.	Max.	Unit
C _{iss}	Input Capacitance	V _{DS} =1200V, f=1MHz, V _{AC} =25mV		6460		pF
C _{OSS}	Output Capacitance			198		pF
C _{rss}	Reverse Transfer Capacitance			16		pF
g _{fs}	Transconductance	V _{DS} =20V, I _D =50A		52		S
E _{OSS}	C _{OSS} Stored Energy	V _{DS} =1200V, f=1MHz		152		μJ
E _{ON}	Turn-On Energy (Body Diode)	V _{DS} =1200V, V _{GS} =-5V/18V, I _D =50A, L=150uH T _J =175°C		0.76		mJ
E _{OFF}	Turn-Off Energy (Body Diode)			0.2		mJ
Q _g	Total Gate Charge	V _{DS} =1200V, V _{GS} =-5V/18V, I _D = 50A		168		nC
Q _{gs}	Gate-source Charge			52		nC
Q _{gd}	Gate-Drain Charge			50		nC
R _{G(int)}	Internal Gate Resistance	f=1MHz, V _{AC} =25mV		2.5		Ω
t _{d(on)}	Turn-on Delay Time	V _{DS} =1200V, V _{GS} =-5V/18V, I _D =50A, L=150μH Rext=2.5Ω		32		ns
t _r	Rise Time			35		ns
t _{d(off)}	Turn-off Delay Time			60		ns
t _f	Fall Time			15		ns

Typical Performance-Reverse Diode(T_J = 25°C unless otherwise specified)

Symbol	Parameter	Test Conditions	Min.	Typ.	Max.	Unit
V _{FSD}	Forward Voltage	V _{GS} =0V, I _F =37.5A, T _J =25°C		3.2	6	V
		V _{GS} =0V, I _F =37.5A, T _J =175°C		2.9	6	V
I _S	Continuous Diode Forward Current	V _{GS} =0V, T _C =25°C		100		A
t _{rr}	Reverse Recovery Time	V _{GS} =-5V, I _F =50 A, V _R =1200 V,		33		nS
Q _{rr}	Reverse Recovery Charge			918		nC
I _{rrm}	Peak Reverse Recovery Current	di/dt=1900A/μs, T _J =175°C		38		A

Thermal Characteristics

Symbol	Parameter	Value.	Unit
R _{θJC}	Thermal Resistance, Junction-to-Case	0.31	°C/W
R _{θJA}	Thermal Resistance, Junction-to-Ambient	40	°C/W

The values are based on the junction-to case thermal impedance which is measured with the device mounted to a large heat sink assuming maximum junction temperature of T_J(max)=175°C

Electrical Characteristics

Fig1. Output characteristics ($T_J = 25^\circ\text{C}$)

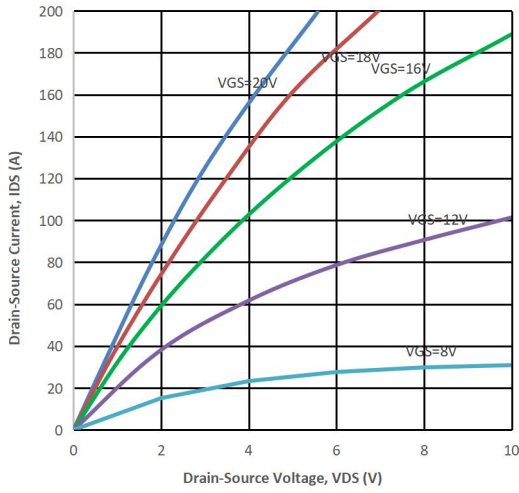

Fig2. Output characteristics ($T_J = 175^\circ\text{C}$)

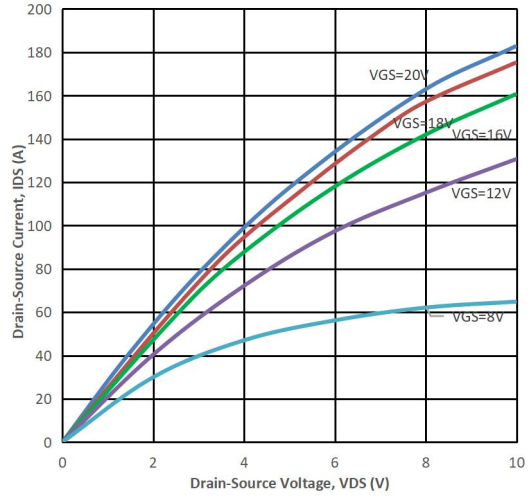

Fig3. Normalized On-Resistance vs. Temperature

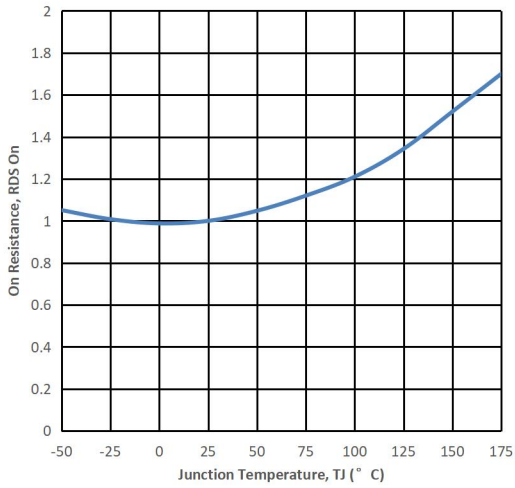

Fig4. On-Resistance vs. Temperature

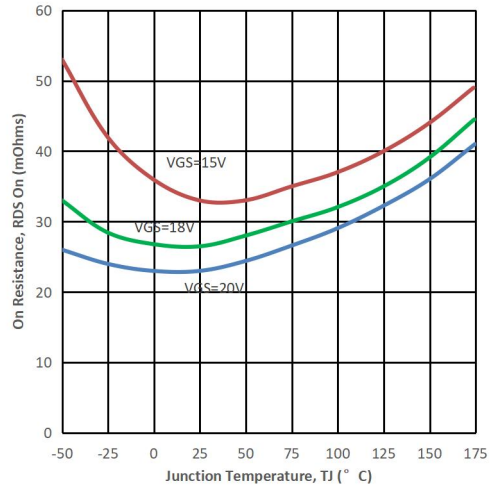

Fig5. Transfer Characteristic

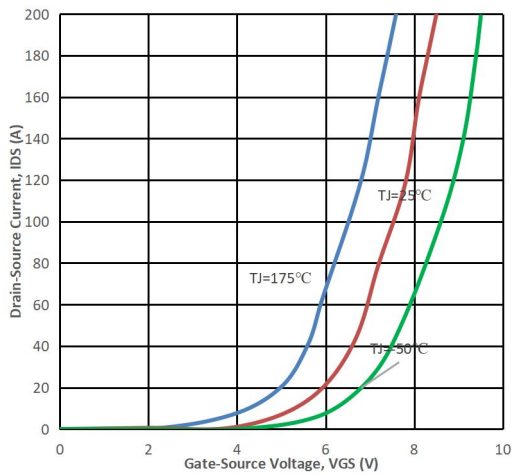

Fig6. Body Diode Characteristic at 25 °C

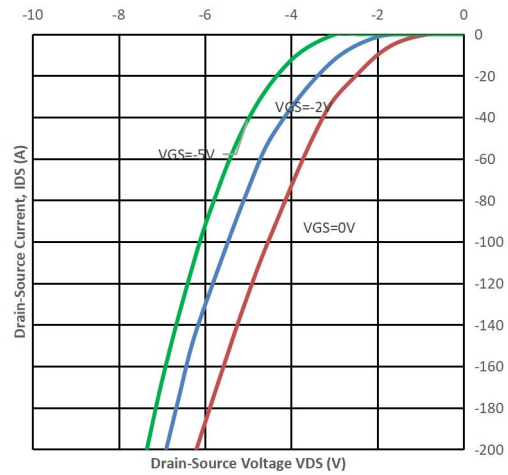

Fig7. Threshold Voltage vs. Temperature

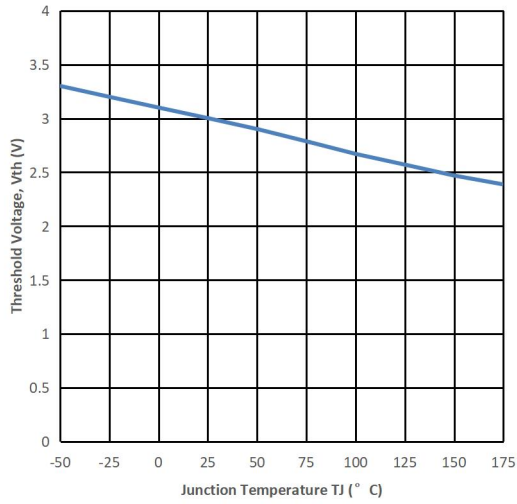

Fig8. Gate Charge Characteristics

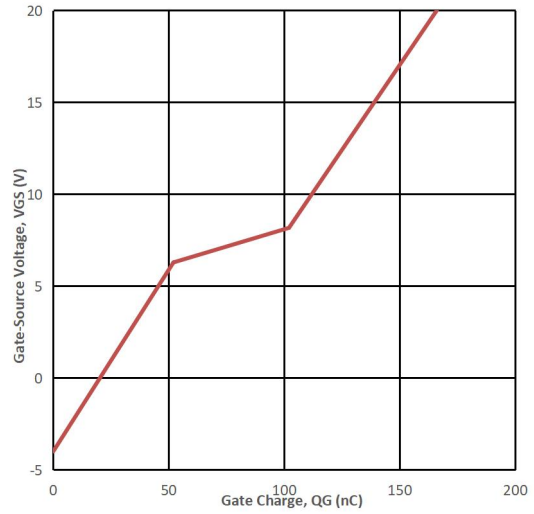

Fig9. 3rd Quadrant Characteristic at 25 °C

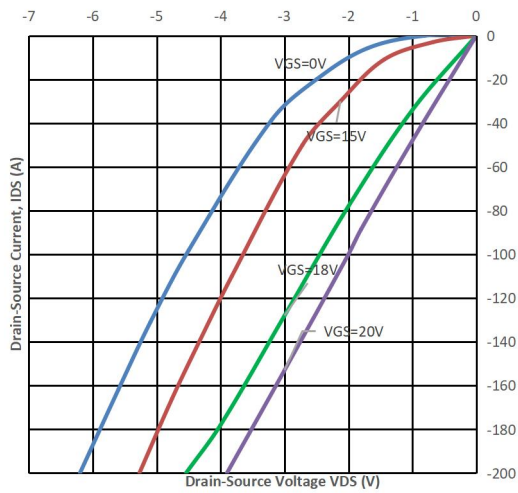

Fig10. Output Capacitor Stored Energy

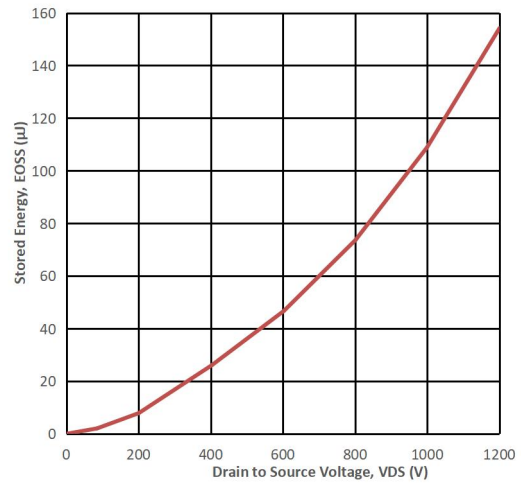

Fig11. Capacitances vs. Drain-Source

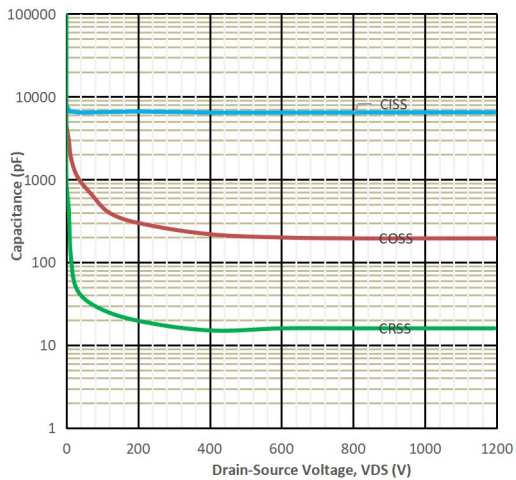

Fig12. Max Power Dissipation Derating Vs Tc

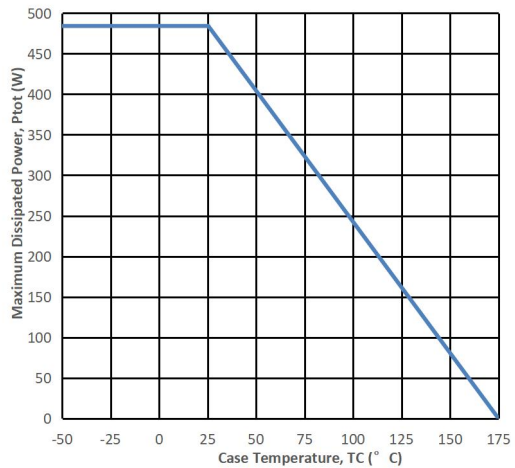

Fig13. Switching Energy vs. Drain Current

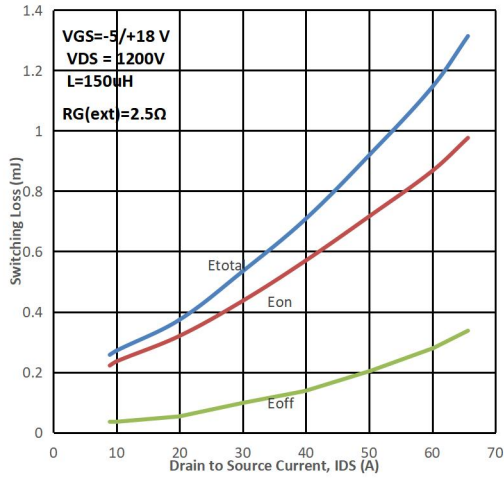

Fig14. Switching Energy vs. $R_{G(ext)}$

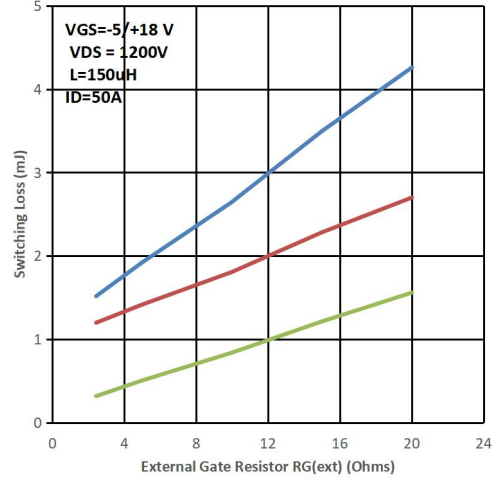

Fig15. Switching Energy vs. Temperature

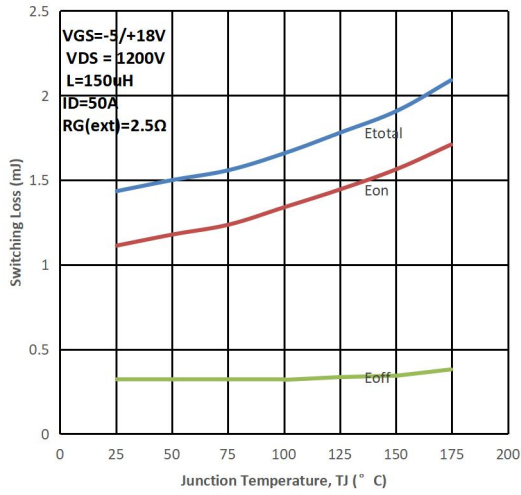

Fig16. Switching Times vs. $R_{G(ext)}$

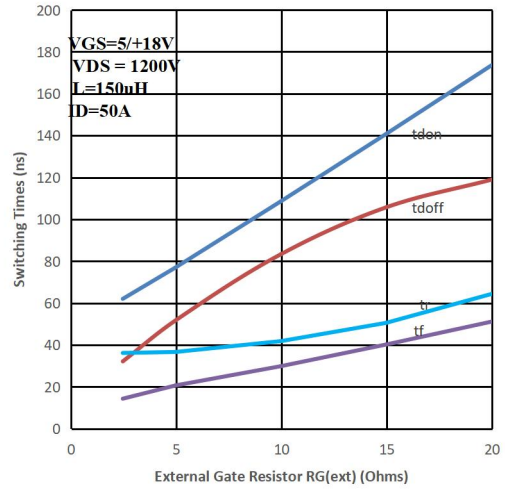

Fig17. Transient Thermal Impedance

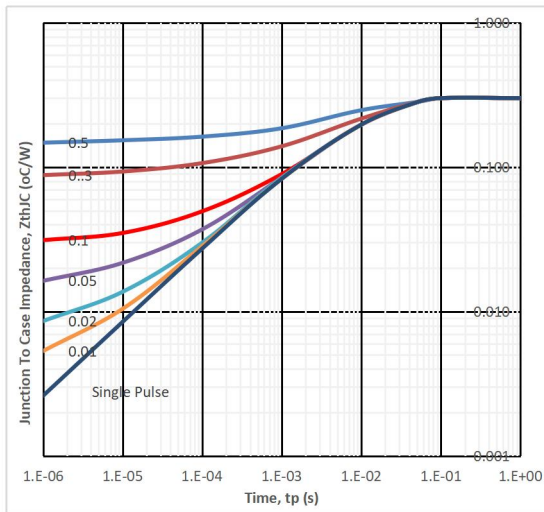
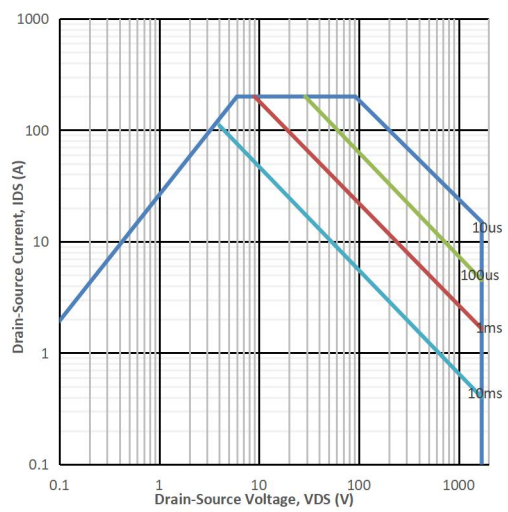
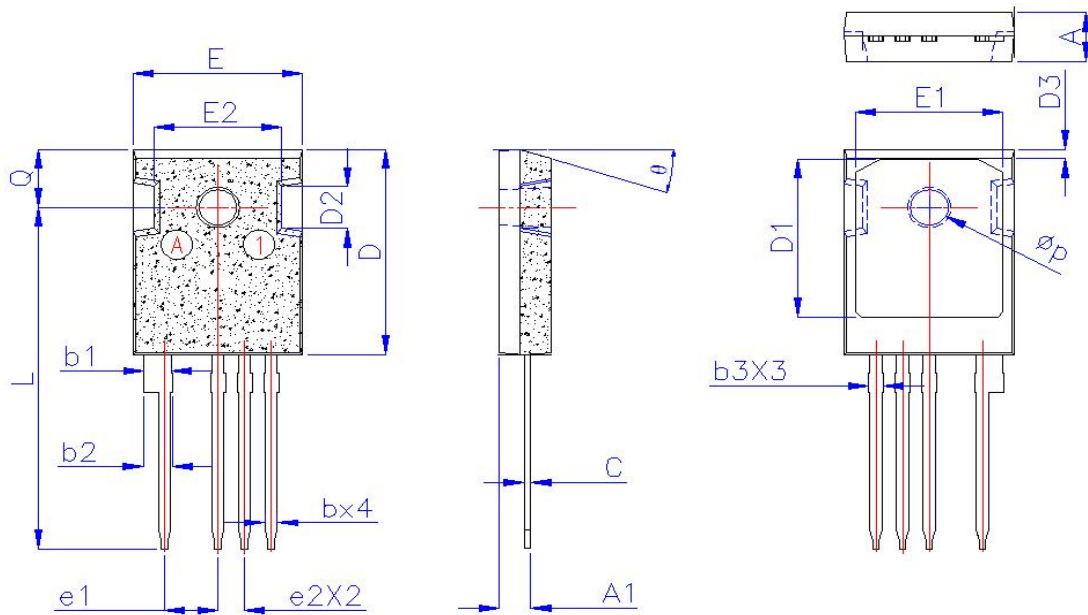

Fig18. Safe Operating Area



Package Drawing:

Dimensions (UNIT: mm)

SYMBDLS	DIMENSIONS IN MILLIMETERS			DIMENSIONS IN INCHES		
	MIN	TYPE	MAX	MIN	TYPE	MAX
A	4.80	5.00	5.20	0.189	0.197	0.205
A1	2.85	3.00	3.15	0.112	0.118	0.124
b	1.15	1.20	1.25	0.045	0.047	0.049
b1	2.40	2.50	2.60	0.094	0.098	0.102
b2	2.61	2.76	2.91	0.103	0.109	0.115
b3	1.30	1.42	1.57	0.051	0.056	0.062
C	0.55	0.60	0.65	0.022	0.024	0.026
D	20.80	21.00	21.20	0.819	0.827	0.835
D1	15.94	16.24	16.54	0.628	0.639	0.651
D2	4.3TYPE			0.169TYPE		
e1	4.93	5.08	5.23	0.194	0.200	0.206
e2	2.39	2.54	2.69	0.094	0.100	0.106
E	15.95	16.15	16.35	0.628	0.636	0.644
E1	13.82	14.02	14.26	0.544	0.552	0.561
E2	12.00	12.20	12.40	0.472	0.480	0.488
L	34.65	35.05	35.45	1.364	1.380	1.396
Q	5.85	5.95	6.05	0.230	0.234	0.238
ϕP	3.45	3.60	3.75	0.136	0.142	0.148
θ	17.5°			0.689°		