

Technical Specification

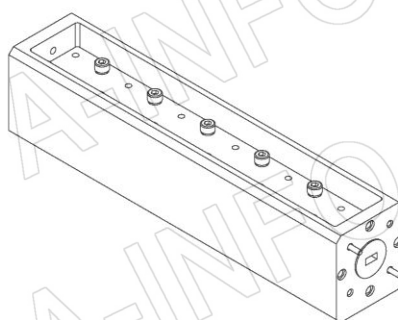

EIA WR	WR19
Frequency Range(GHz)	40.0 - 60.0
Attenuation(dB)	10
Attenuation Accuracy(dB)	±1.5 Max.
VSWR	1.30:1 Max.
Power Handling(W CW)	1
Flange	FUGP500(UG-383/U-M)
Material	Cu
Size(mm)	139.7 x 28.6 x 31.7
Net Weight(Kg)	0.63 Around

Outline Drawing (Size: mm)



AINFO Inc.

Page 1 of 3

China(Beijing): Tel: (+86) 10-6266-7326,
China(Chengdu): Tel: (+86) 28-8519-2786,
USA: Tel: (+1) 949-639-9688,

(+86) 10-6266-7327 Fax: (+86) 10-6266-7379
(+86) 28-8519-3044 Fax: (+86) 28-8519-3068
(+1) 949-639-9608 Fax: (+1) 949-639-9670

Website: www.ainfoinc.com
Email: sales@ainfoinc.com

Flange Drawing (Size: mm)

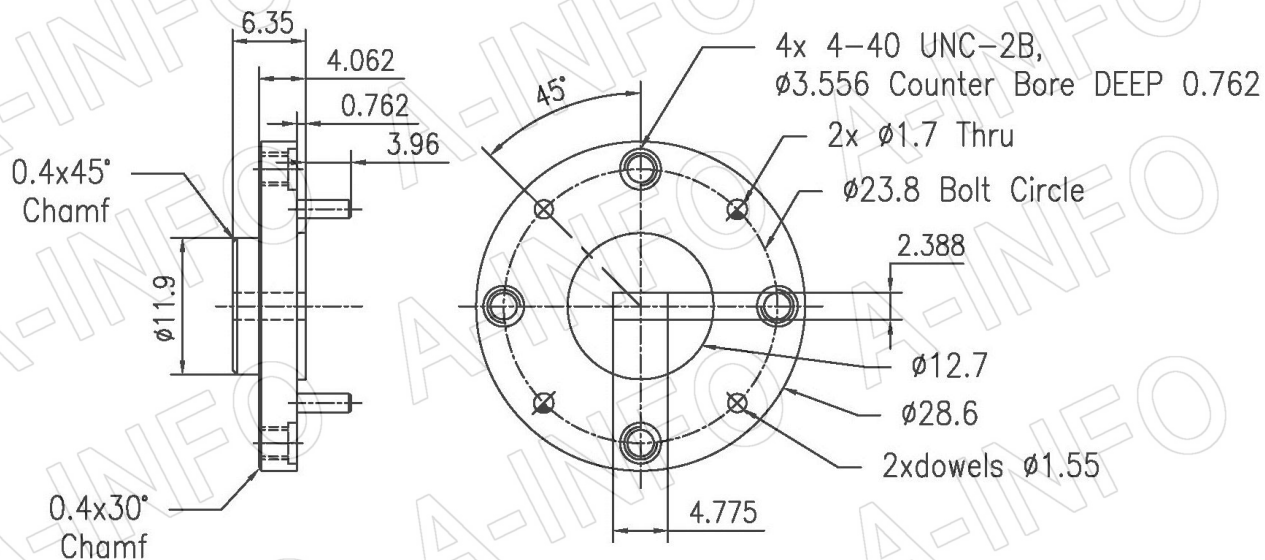

FUGP500
(equivalent to UG-383/U-M)

AINFO Inc.

Page 2 of 3

China(Beijing): Tel: (+86) 10-6266-7326,
China(Chengdu): Tel: (+86) 28-8519-2786,
USA: Tel: (+1) 949-639-9688,

(+86) 10-6266-7327 Fax: (+86) 10-6266-7379
(+86) 28-8519-3044 Fax: (+86) 28-8519-3068
(+1) 949-639-9608 Fax: (+1) 949-639-9670

Website: www.ainfoinc.com
Email: sales@ainfoinc.com

Test Result

Attenuation & VSWR

