

Technical Specification

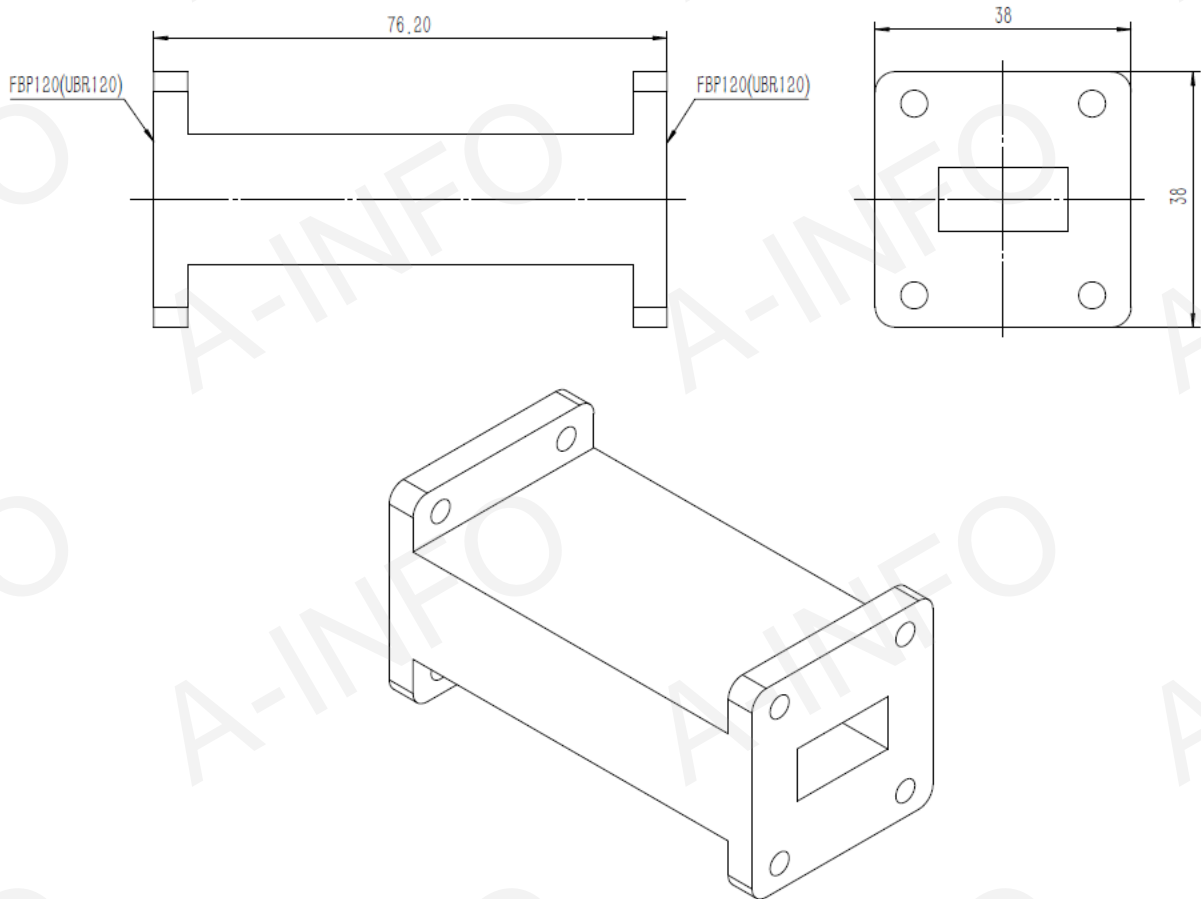

EIA WR	WR75
Frequency Range(GHz)	10.0-15.0
Attenuation(dB)	10
Accuracy(dB)	±1.5 Max.
VSWR	1.25 Max.
Flange	FBP120(UBR120)
Power Handling(W)	1
Material	Cu
Net Weight(Kg)	0.42 Around

Outline Drawing (Size: mm)



Flange Drawing (Size: mm)

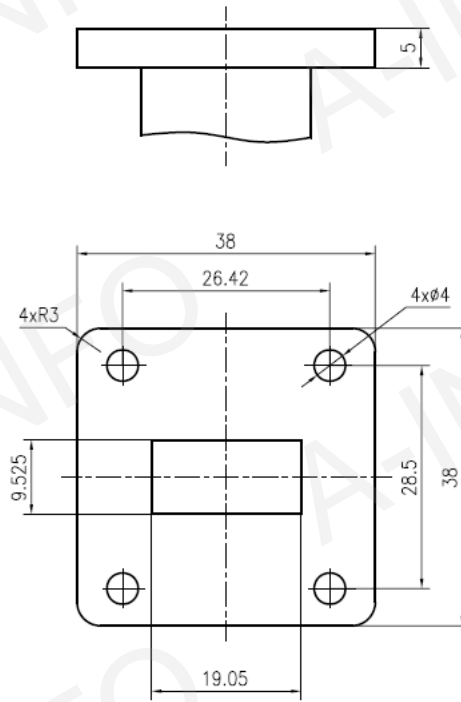

FBP120

Test Results

