

For reference only. See data sheet for the detailed specifications.

## Technical Specification



EIA WR	WR19
Frequency Range(GHz)	40.0 – 60.0
Attenuation(dB)	6
Attenuation Accuracy(dB)	±1.3 Max.
Attenuation Sensitivity(dB)	±0.9 Max.
VSWR	1.15:1 Max.
Average Power(W CW)	0.6
Peak Power(KW)	0.3
Flange	FUGP500(UG-383/U-M)
Material	Cu
Size(mm)	139.7 x 28.6 x 31.7
Net Weight(Kg)	0.64 Around

## Outline Drawing (Size: mm)

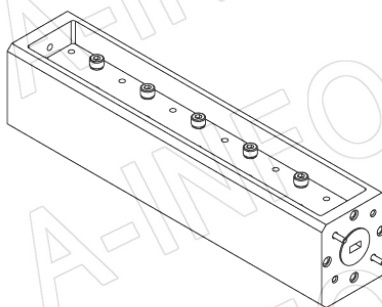
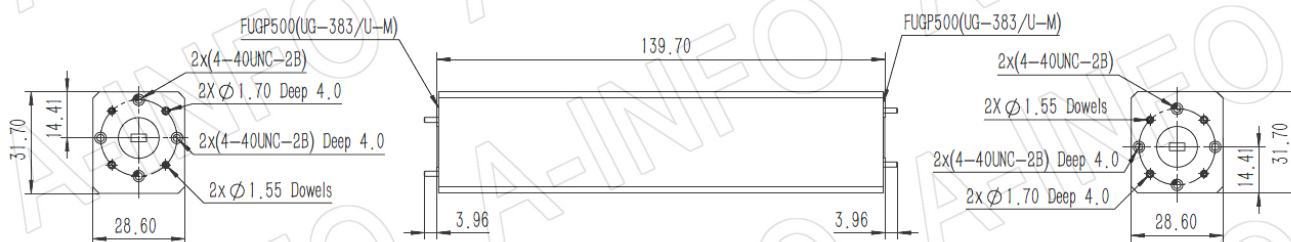

## Flange Drawing (Size: mm)

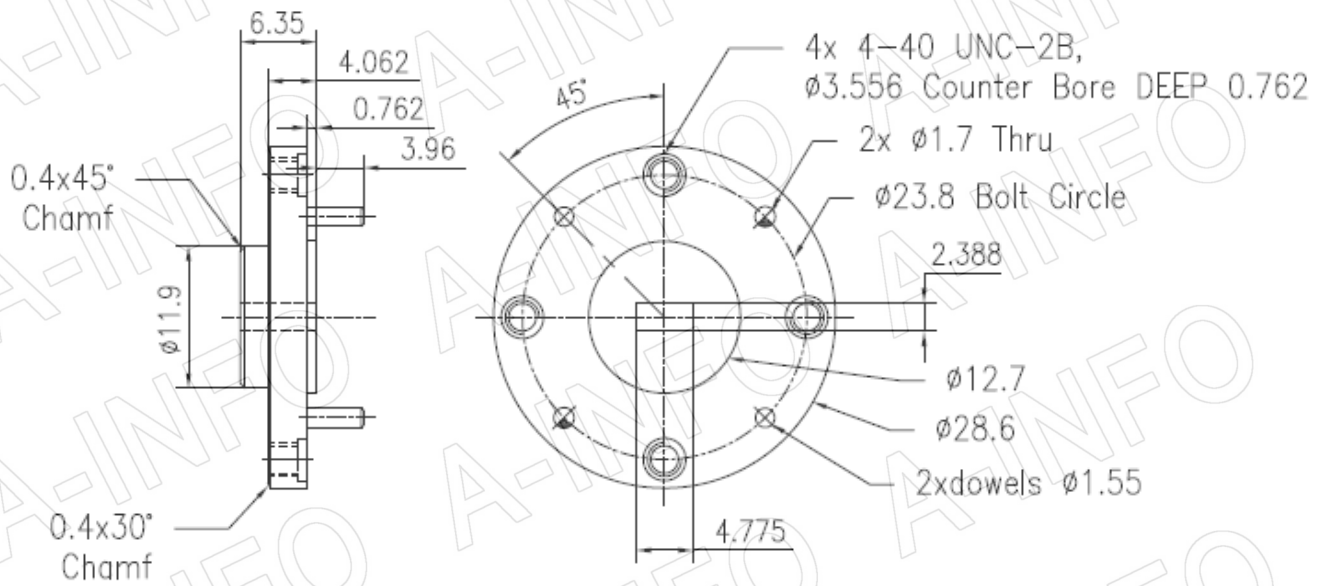

FUGP500

(equivalent to UG-383/U-M)

## Test Results

### Attenuation & VSWR

