

For reference only. See data sheet for the detailed specifications.

Technical Specification

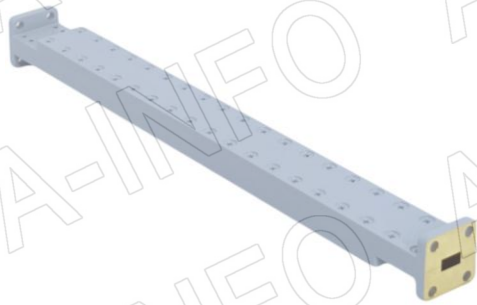

| EIA WR | WR28 |
|-----------------------------|---------------------|
| Frequency Range(GHz) | 26.5 – 40.0 |
| Attenuation(dB) | 10 |
| Attenuation Accuracy(dB) | ±1.0 Max. |
| Attenuation Sensitivity(dB) | ±0.9 Max. |
| VSWR | 1.10:1 Max. |
| Average Power(W CW) | 0.5 |
| Peak Power(KW) | 0.5 |
| Flange | FBP320(UBR320) |
| Material | Cu |
| Size(mm) | 203.2 x 19.1 x 23.6 |
| Net Weight(Kg) | 0.25 Around |

Outline Drawing (Size: mm)

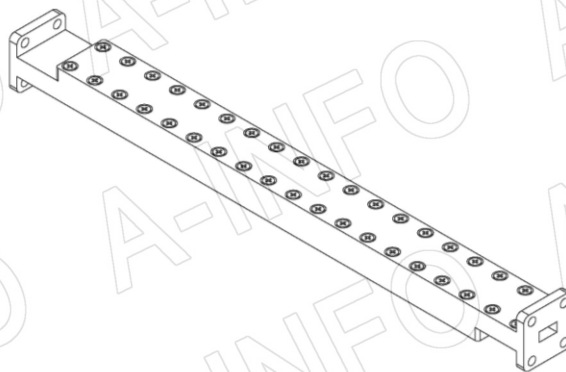
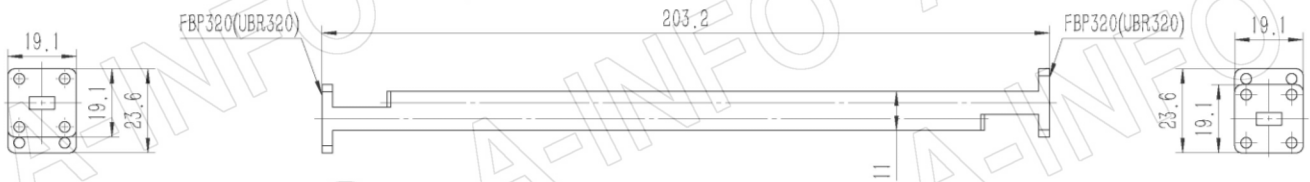

AINFO Inc.

Page 1 of 3

China(Beijing): Tel: (+86) 10-6266-7326,
 China(Chengdu): Tel: (+86) 28-8519-2786,
 USA : Tel: (+1) 949-639-9688,

(+86) 10-6266-7327 Fax: (+86) 10-6266-7379
 (+86) 28-8519-3044 Fax: (+86) 28-8519-3068
 (+1) 949-639-9608 Fax: (+1) 949-639-9670

Website: www.ainfoinc.com
 Email: sales@ainfoinc.com

Flange Drawing (Size: mm)

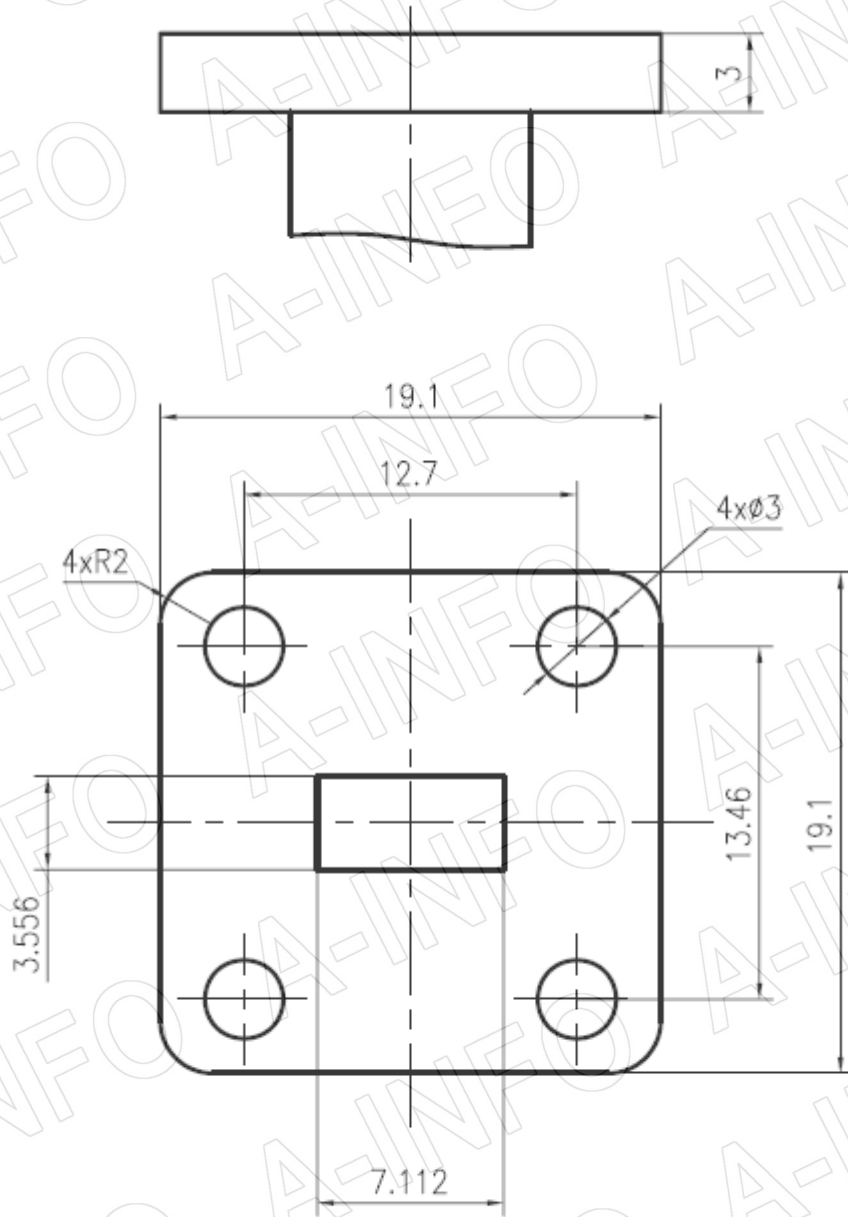

FBP320

AINFO Inc.

Page 2 of 3

China(Beijing): Tel: (+86) 10-6266-7326,
China(Chengdu): Tel: (+86) 28-8519-2786,
USA: Tel: (+1) 949-639-9688,

(+86) 10-6266-7327 Fax: (+86) 10-6266-7379
(+86) 28-8519-3044 Fax: (+86) 28-8519-3068
(+1) 949-639-9608 Fax: (+1) 949-639-9670

Website: www.ainfoinc.com
Email: sales@ainfoinc.com

Test Result

Attenuation & VSWR

